

PULSED POWER SYSTEM

脈衝功率系統



Po-Yu Chang

Institute of Space and Plasma Sciences, National Cheng Kung University

2023 Fall Semester

Tuesday 9:10-12:00

Lecture 2

<http://capst.ncku.edu.tw/PGS/index.php/teaching/>

Online courses:

<https://nckucc.webex.com/nckucc/j.php?MTID=md577c3633c5970f80cbc9e821927e016>

Grading



- **Weekly presentations – 30 %**
 - **Class review.**
- **Final presentations – 70 %**
 - **Design of a pulsed-power system – 35 %.**
 - **Applications of pulsed-power system – 35 %.**

- **No class on 10/31!!!**

Reference



- **Foundations of pulsed power technology, by Jane Lehr & Pralhad Ron**
- **Pulsed power systems, by H. Bluhm**
- **Pulsed power, by Gennady A. Mesyats**
- **J. C. Martin on pulsed power, edited by T. H. Martin, A. H. Guenther, and M. Kristiansen**
- **Pulse power formulary, by Richard J. Adler**

- **Circuit analysis, by Cunningham and Stuller**

Outlines



- **Introduction to pulsed-power system**
- **Review of circuit analysis**
- **Static and dynamic breakdown strength of dielectric materials**
 - **Gas – Townsend discharge (avalanche breakdown), Paschen's curve**
 - **Liquid**
 - **Solid**
- **Energy storage**
 - **Pulse discharge capacitors**
 - **Marx generators**
 - **Inductive energy storage**

Outlines



- **Switches**
 - **Closing switches**
 - **Opening switches**
- **Pulse-forming lines**
 - **Blumlein line**
 - **Pulse-forming network**
 - **Pulse compressor**
- **Pulse transmission and transformation**
 - **Self-magnetic insulation**
 - **Pulse transformer**
 - **Voltage multiplier**
 - **H-bridge pulse generator**
 - **Fast high-voltage pulse generator**

Outlines



- **Power and voltage adding**
 - Marx generator
 - LC generator
 - Line pulse transformers
 - Induction voltage adder (IVA)
 - Linear induction accelerator (LIA)
 - Linear transformer driver (LTD)
- **Diagnostics**
 - Voltage measurement
 - Current measurement
- **Applications of pulsed-power system**

Outlines



- **Introduction to pulsed-power system**
- Review of circuit analysis
- Static and dynamic breakdown strength of dielectric materials
 - Gas – Townsend discharge (avalanche breakdown), Paschen's curve
 - Liquid
 - Solid
- Energy storage
 - Pulse discharge capacitors
 - Marx generators
 - Inductive energy storage

In general, a pulsed-power system provides a power in the order of 1 GW



- The highest energy and power that have been achieved in a single pulse are in the order of 100 MJ & few hundreds TW, respectively.

	General cases	Our system
Energy per pulse	1 ~ 10 MJ	1 kJ
Peak power	1 MW ~ 100 TW	0.6 GW
Peak voltage	1 kV ~ 10 MV	20 kV
Peak current	1 kA ~ 10 MA	135 kA
Pulse width	0.1 ns ~ 10 us	1 us

A pulse is characterized by its shapes



- The shape of a pulse is characterized by:
 - Rise time: from 10 % to 90 % of the plateau
 - Fall time: from 90 % to 10 % of the plateau

(Rise & fall time depend on the evolution of the “load impedance,” which in most cases varies with time.)

- Duration:
 - FWHM
 - Width of 90% of the peak amplitude
- Flatness of the plateau region: important for some applications such as for driving a Pockel’s cell.

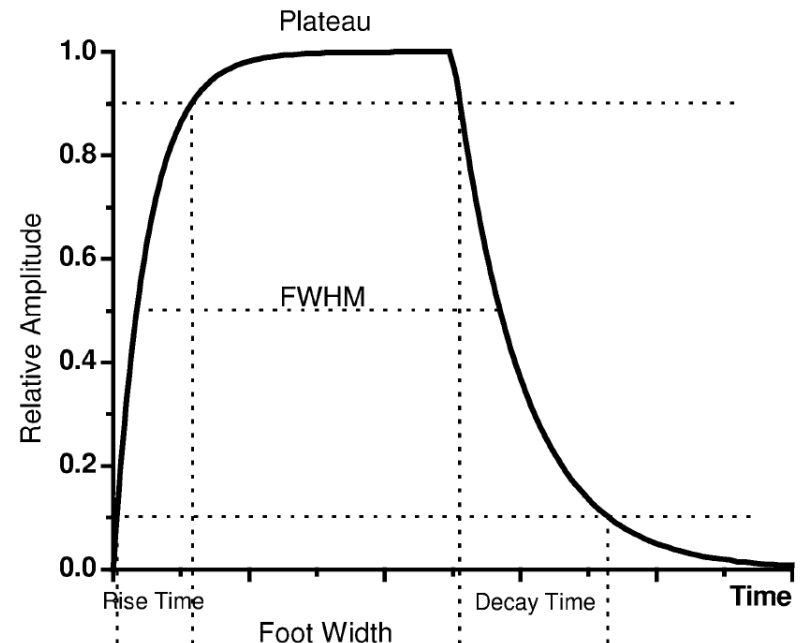

A pulsed-power system has an energy bank that is charged slowly and store the energy for some time



- A generator scheme for the production of high-power electrical pulses is always based on an energy store that is charged slowly at a relatively low charging power and is discharged rapidly by activating a switch.
- To achieve the desired power magnification factor and to shape the pulse, the above process can be repeated several time.

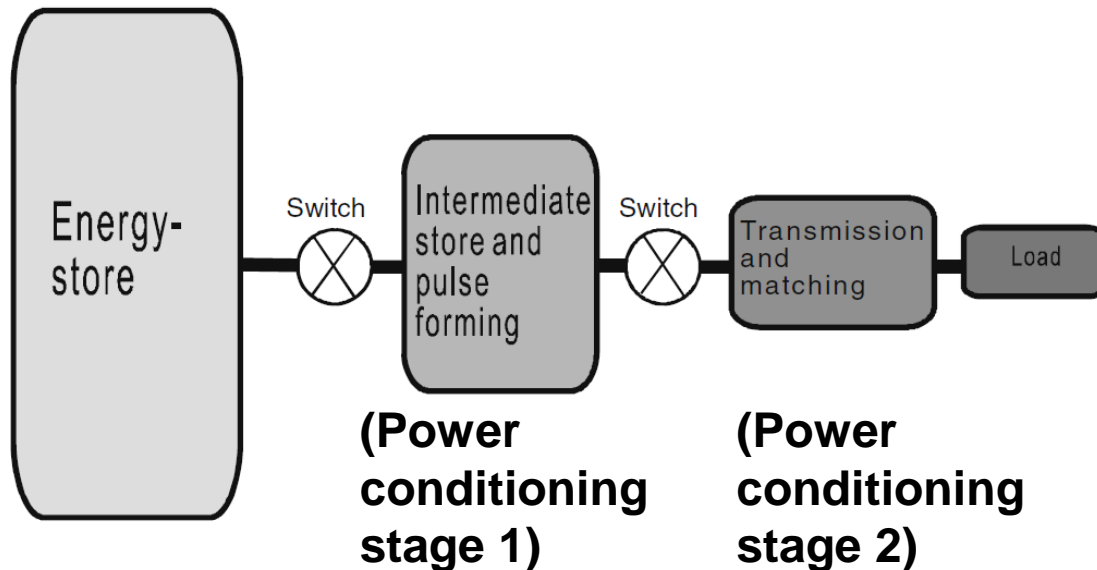

- The energy can be stored either chemically (battery), mechanically, or electrically.

More energy can be stored in a magnetic field



Mechanical Energy	Electrical energy	Magnetic energy
$1.6 \times 10^8 \text{ J/m}^3$	$8 \times 10^4 \text{ J/m}^3$	$7 \times 10^7 \text{ J/m}^3$

- The energy density stored in a magnetic field can be about 2~3 orders of magnitude higher than that storable in a electric field!
- Capacitive storage:
 - Requires one or more closing switches which remain open during charging and hold the charging voltage.
 - Power multiplication is done by current amplification.
- Inductive storage:
 - Requires an opening switch which is closed during charge-up, carrying a large current at this stage.
 - Power multiplication is done by voltage amplification.
- Opening switches are harder to operate than closing switches. They are generally slower leading to a lower power output.

It is more complicated to use inductive storage



- **Capacitive storage:**

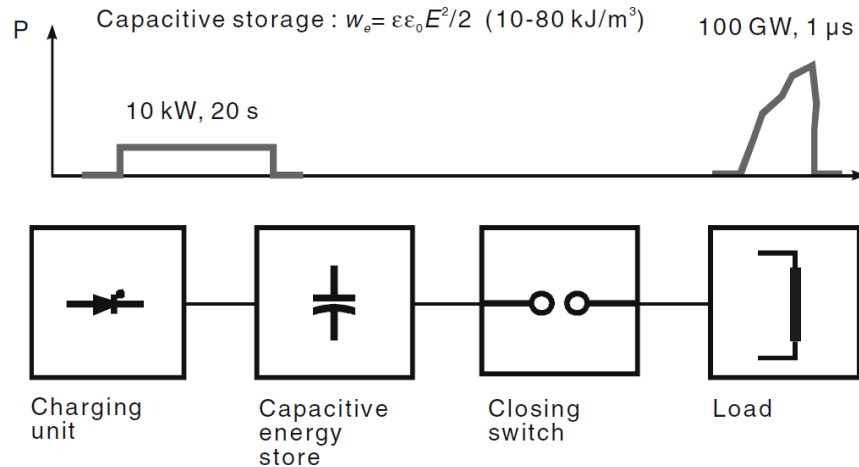

- **Inductive storage:**

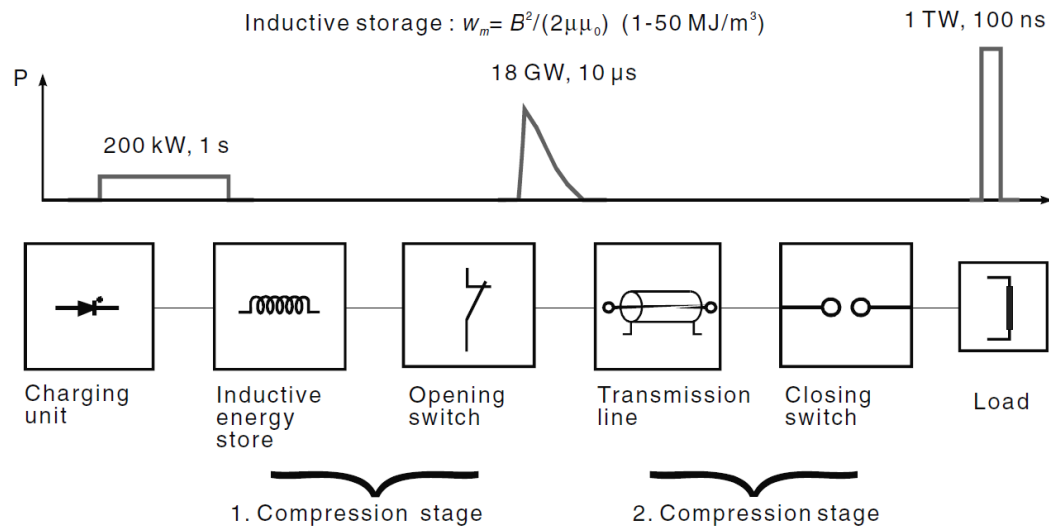

• **Capacitive storage is more common and easier to operate.**

Outlines



- Introduction to pulsed-power system
- **Review of circuit analysis**
- Static and dynamic breakdown strength of dielectric materials
 - Gas – Townsend discharge (avalanche breakdown), Paschen's curve
 - Liquid
 - Solid
- Energy storage
 - Pulse discharge capacitors
 - Marx generators
 - Inductive energy storage

Kirchhoff's current law



- At any instant in time, the algebraic sum of all currents leaving any closed surface is zero.

$$i_1 + i_2 + \dots + i_N = 0$$

or in abbreviated notation:

$$\sum_{k=1}^N i_k = 0$$

where i_k is the k^{th} current of the N currents leaving the closed surfaces.

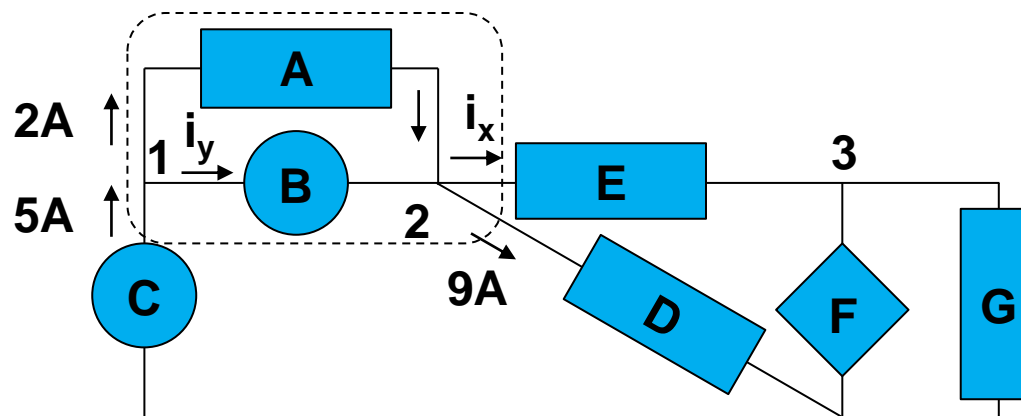

$$i_y + 2 - 5 = 0$$

$$i_y = 3(\text{A})$$

$$-5 + i_x + 9 = 0$$

$$i_x = -4(\text{A})$$

$$2 + i_y - i_x - 9 = 0$$

Kirchhoff's voltage law



- At any instant in time, the algebraic sum of all voltage drops taken around any closed path is zero.

$$V_1 + V_2 + \dots + V_N = 0$$

or in abbreviated notation:

$$\sum_{k=1}^N V_k = 0$$

where V_k is the voltage drop, taken in the direction of the path along the k^{th} segment of the N segments in the closed path.

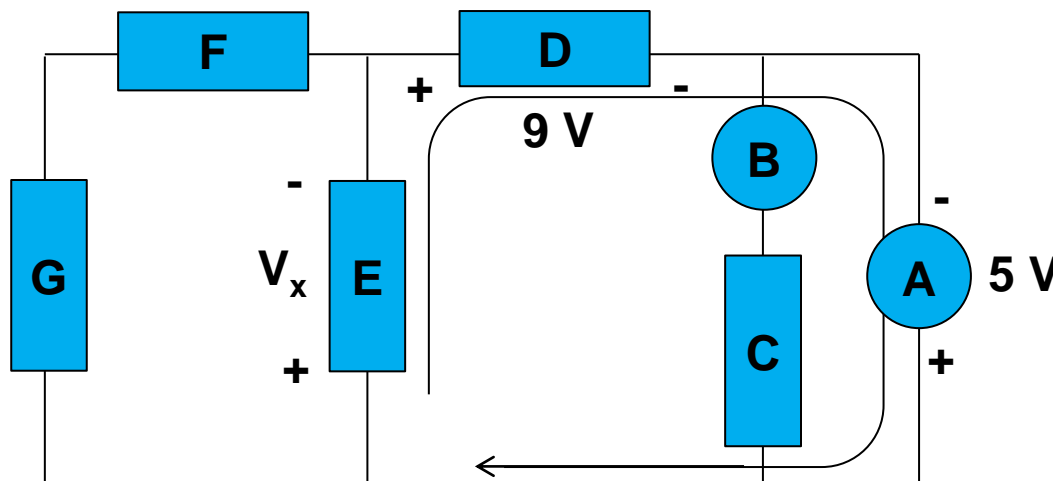

$$-V_x - 9 + 5 = 0$$

$$V_x = -4 \text{ (V)}$$

Source-free RC circuit



- Assuming that the capacitor is fully charged to V_0 .
- At $t=0^+$, the switch is closed.

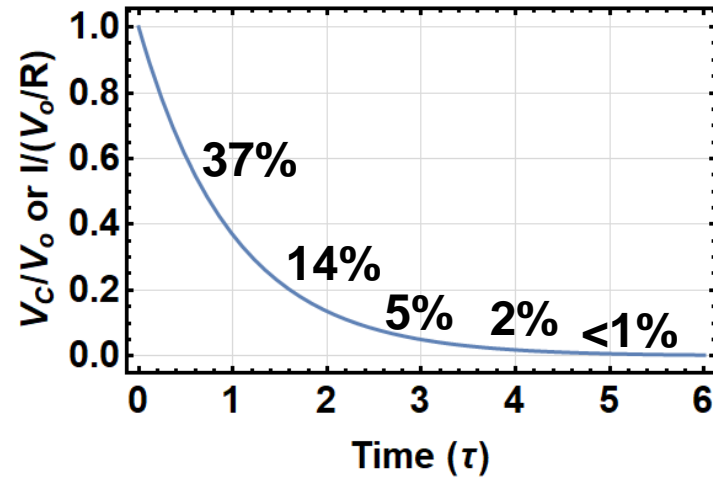
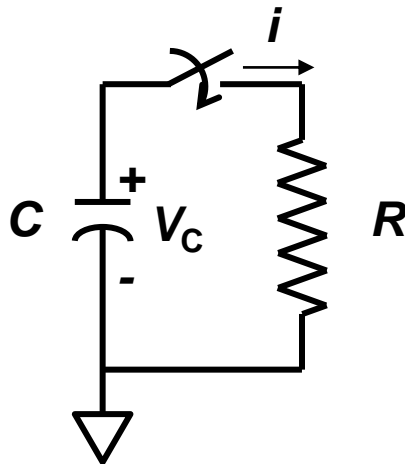

$$V_C(t) = V_0 e^{-t/\tau_C} \quad \tau_C \equiv RC$$

$$I(t) = \frac{V_0}{R} e^{-t/\tau_C}$$

Bleeder resistors dissipate energy in the capacitor for safety



- Example 1:

$V_o = 50 \text{ kV}$, $C = 1 \text{ } \mu\text{F}$, $V \leq 10 \text{ V}$ is safe.

If the bleeder resistor takes 15 mins to dissipate energy in the capacitor, then

$$10 = 50 \text{ k} \text{ Exp} \left(-\frac{15 \times 60}{R \times 10^{-6}} \right) \quad R \sim 100 \text{ M}\Omega$$

- Example 2: SOP for working on high voltage system.

- 1st chicken stick with a large resistors is needed to dissipate the energy in the capacitor slowly first.
- 2nd chicken stick that ground the capacitor is needed after most of the energy is dumped.

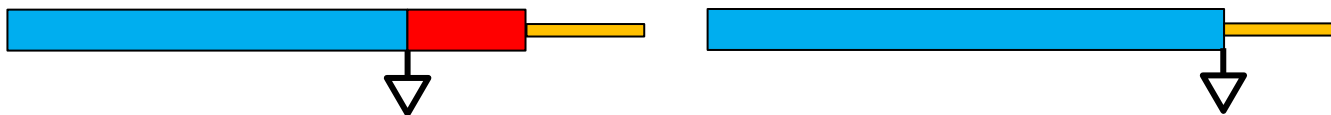
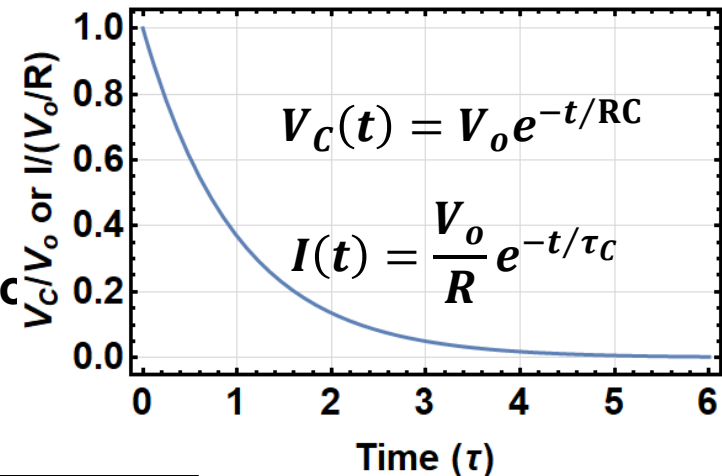
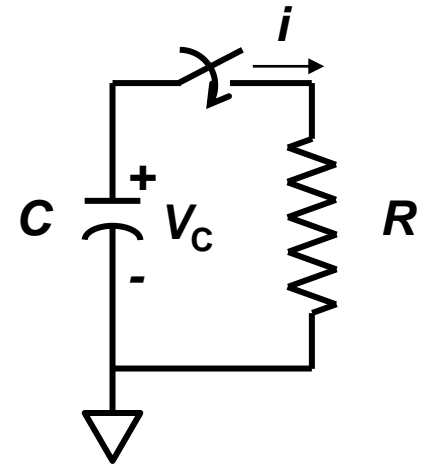

Source-free RL circuit



- Assuming that the current is at steady state for $t \leq 0$, $I(0) = I_0$.
- At $t = 0^+$, the switch is opened/closed.

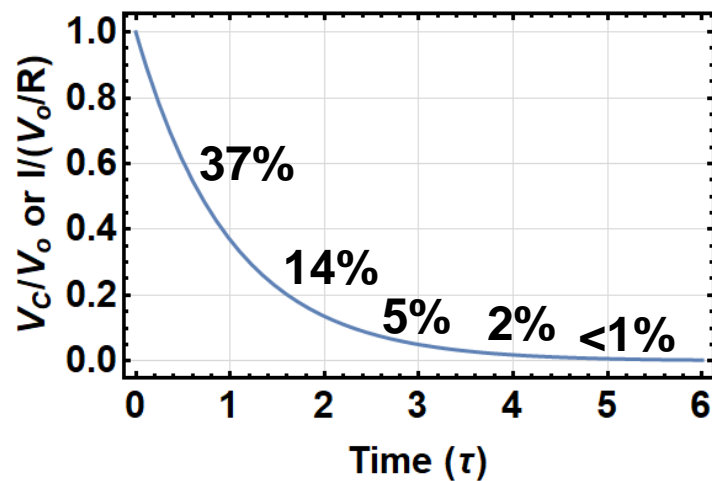
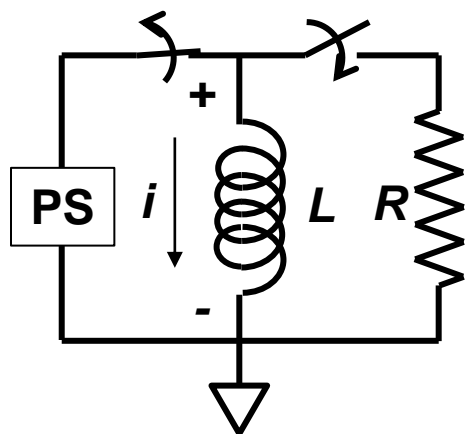

$$I(t) = I_0 e^{-t/\tau_L} \quad \tau_L \equiv \frac{L}{R}$$

$$V(t) = -RI_0 e^{-t/\tau_L}$$

Charging of a capacitor



- Assuming that the capacitor is NOT charged at $t \leq 0$.
- At $t = 0^+$, the switch is closed.

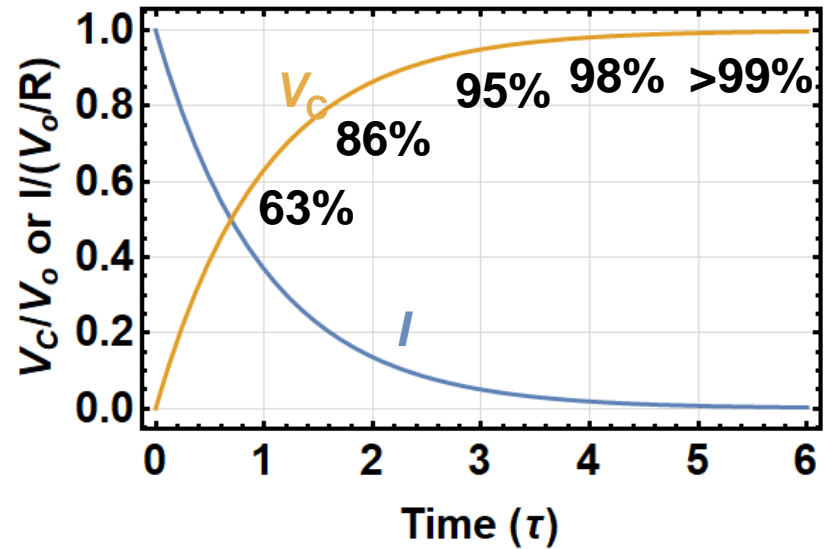
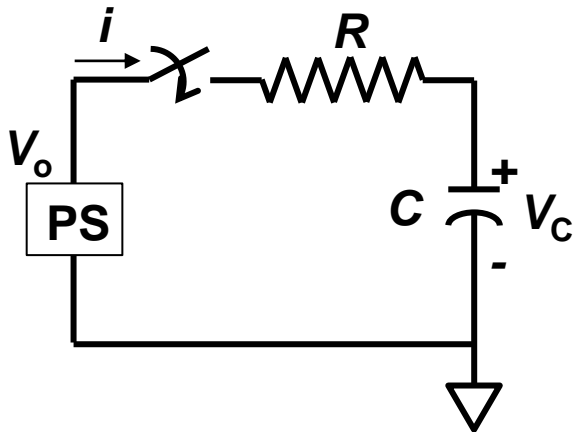

$$V_C = V_o(1 - e^{-t/\tau_c}) \quad \tau_c \equiv RC$$

$$I(t) = \frac{V_o}{R} e^{-t/\tau_c}$$

The capacitor is almost fully charged after 5 time constant

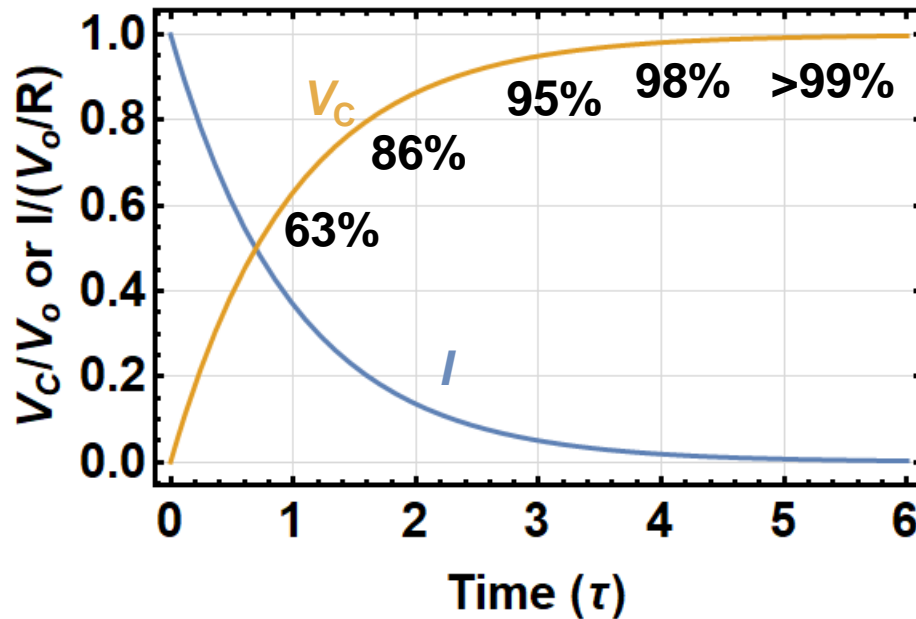

$$V_C = V_o(1 - e^{-t/\tau_C})$$

$$I(t) = \frac{V_o}{R} e^{-t/\tau_C}$$

$$\tau_C \equiv RC$$

Energy is oscillating between the capacitor and the inductor

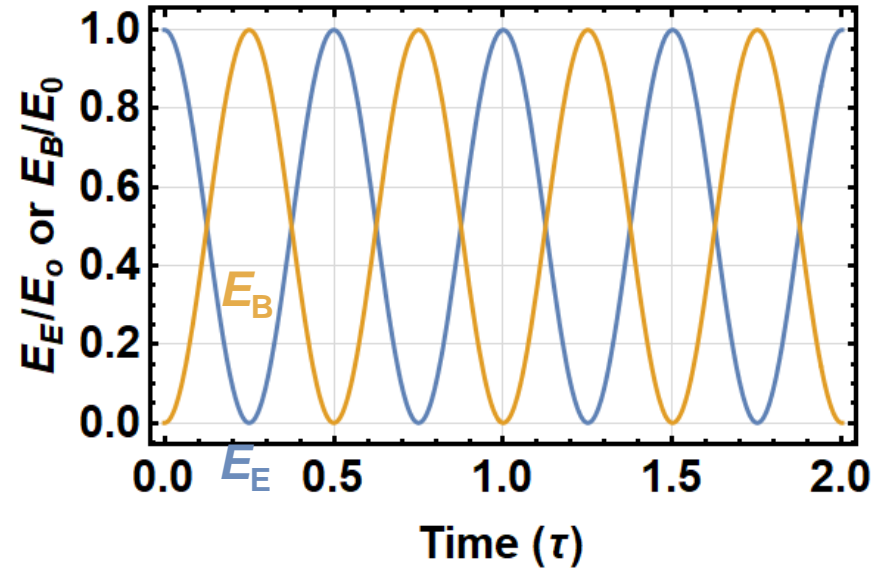
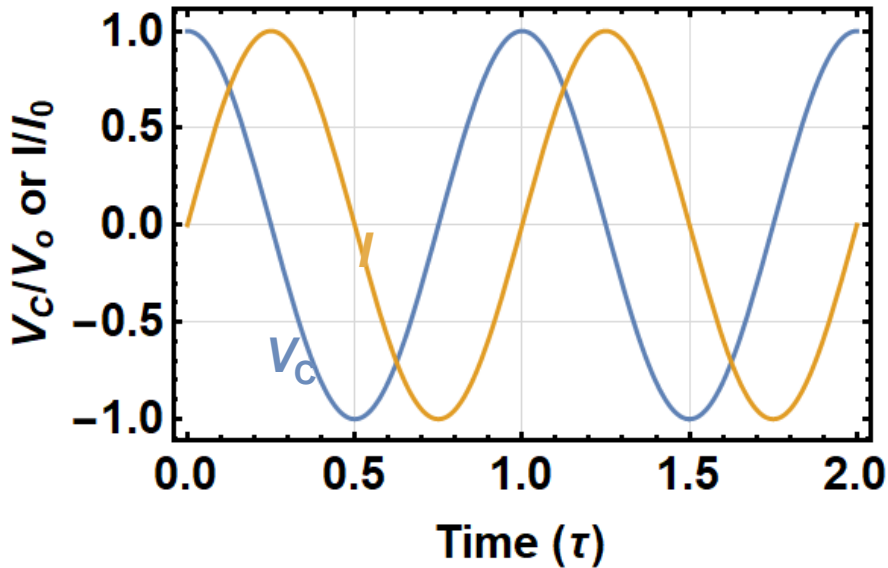

$$V_C = V_o \cos(\omega t) \quad \omega \equiv \frac{1}{\sqrt{LC}}$$

$$i = \frac{V_o}{\sqrt{L/C}} \sin(\omega t)$$

$$E_E = \frac{1}{2} C V_C^2$$

$$E_B = \frac{1}{2} L i^2$$

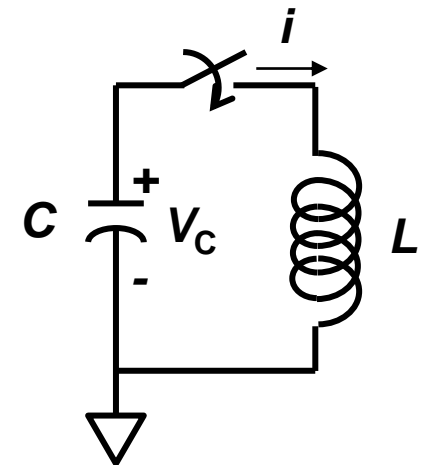

Varying R can move the discharge currents into different regime in Series RLC circuit

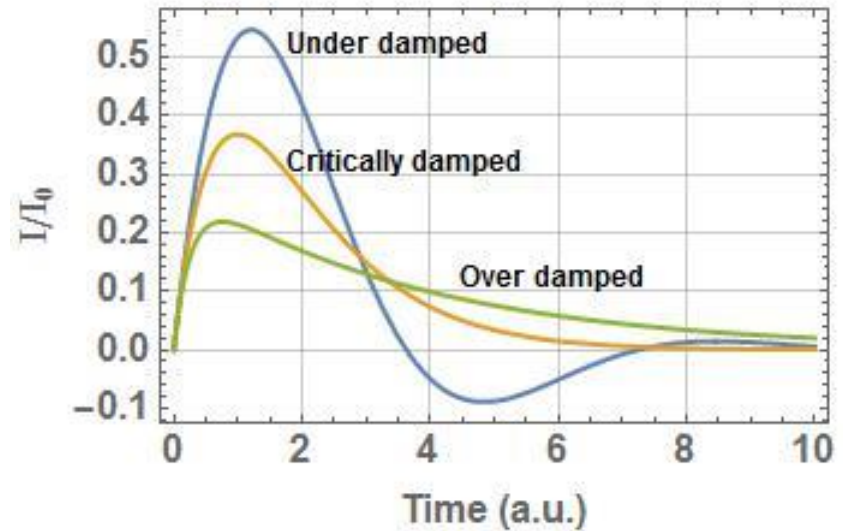
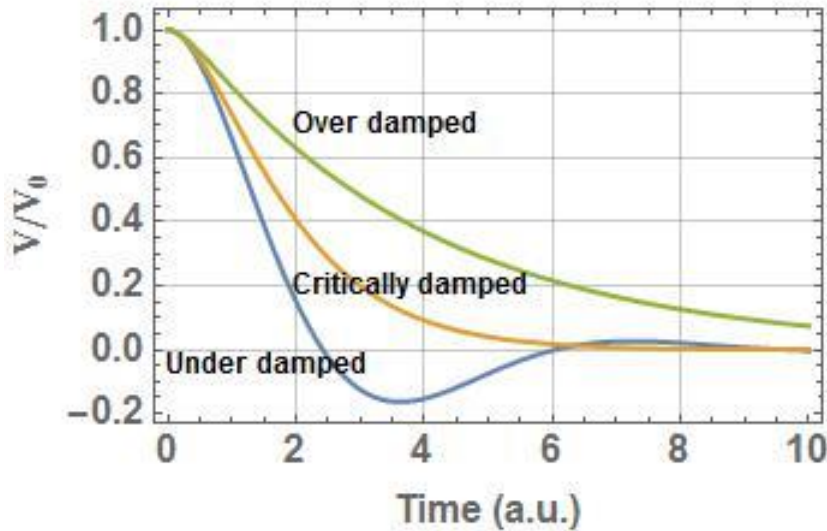

$$R_{\text{cri}} = 2 \sqrt{\frac{L}{C}}$$

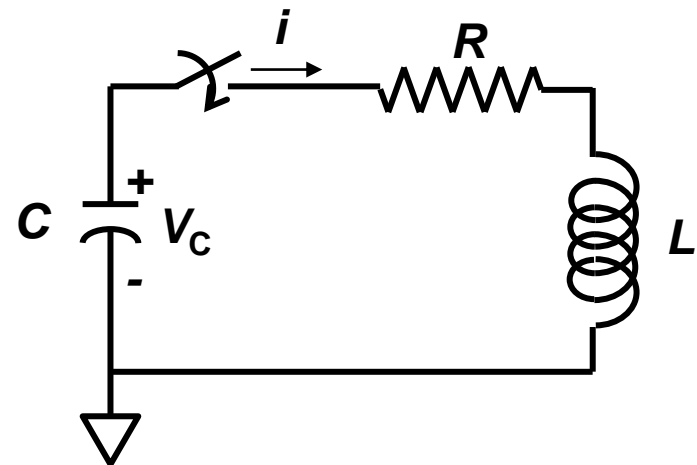

Outlines



- Introduction to pulsed-power system
- Review of circuit analysis
- **Static and dynamic breakdown strength of dielectric materials**
 - **Gas – Townsend discharge (avalanche breakdown), Paschen's curve**
 - **Liquid**
 - **Solid**
- Energy storage
 - Pulse discharge capacitors
 - Marx generators
 - Inductive energy storage

Dielectric materials



- Dielectric substances serve both as “insulators” in generator components such as capacitors, high-voltage (HV) transmission lines, and as “working media” in switches.

- Capacitor



$$E = \frac{1}{2} CV^2$$

- Transmission line



- HV switch

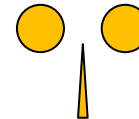

- The properties of these devices are strongly depend on
 - Electric breakdown strength / dielectric strength.
 - Dielectric constant.
- The dielectric strength of an insulant can be defined as “the maximum field stress that the material can withstand for a given time.”

Electric strength also depends on the sample geometry, pressure, temperature, and electrode material.



- **Geometry**

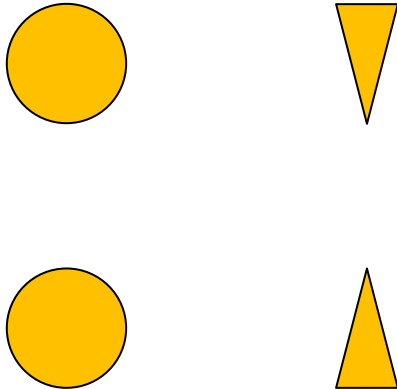

- **Pressure/temperature**

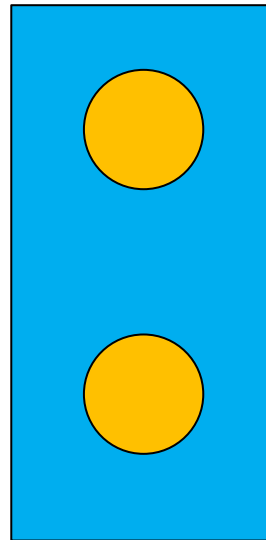

Pressurized/vacuum

- **Electrode material**



Copper/Tungsten

Collisions play an important role in ionization process



- At the microscopic level, breakdown requires the presence of sufficiently energy charge particles that have acquired enough energy from the applied electric field between two energy-dissipating collisions to ionize the material and to create more charge particles.

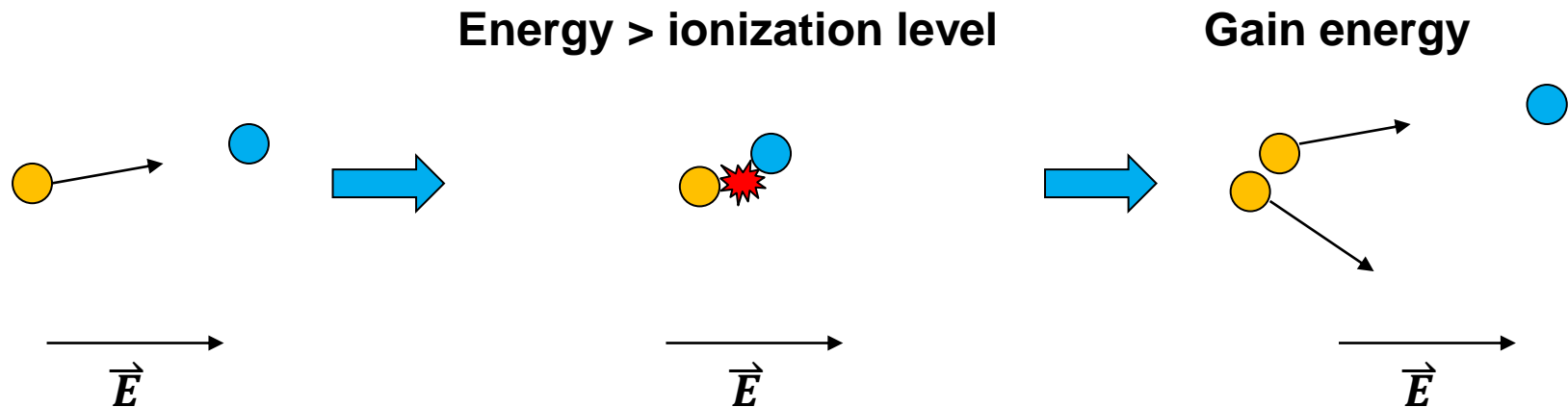

In most cases, electrons dominate the breakdown process since its mobility is much larger than that of ions



$$E_k = \frac{1}{2}mv^2 \quad v = \sqrt{\frac{2E_k}{m}} \quad E_k \sim kT$$

Collision time: $t = \frac{s}{\sqrt{\frac{2E_k}{m}}} \sim \frac{n^{-1/3}}{\sqrt{T}} \sqrt{m}$ $n = \frac{\#}{V} \sim \frac{\#}{S^3}$ $s \sim n^{-1/3}$

$$\frac{m_i}{m_e} \sim 2000 \times \text{Atomic mass}$$

$$\frac{t_i}{t_e} \sim 45 \times \sqrt{A}$$

Mean free path is important in ionization process



- In order for an electron to acquire enough energy between collisions, its mean free path in the material must be sufficient enough.

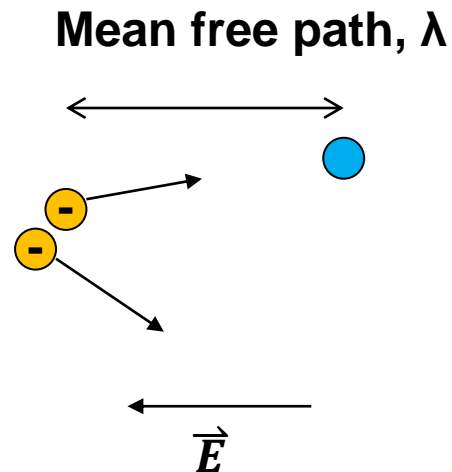

$$E_k = e \times E \times \lambda = eV$$

The dielectric strength should be the same for all materials with the same density



- Mean free path depends essentially on the density of the material. The dielectric strength should be the same for all materials with the same density.

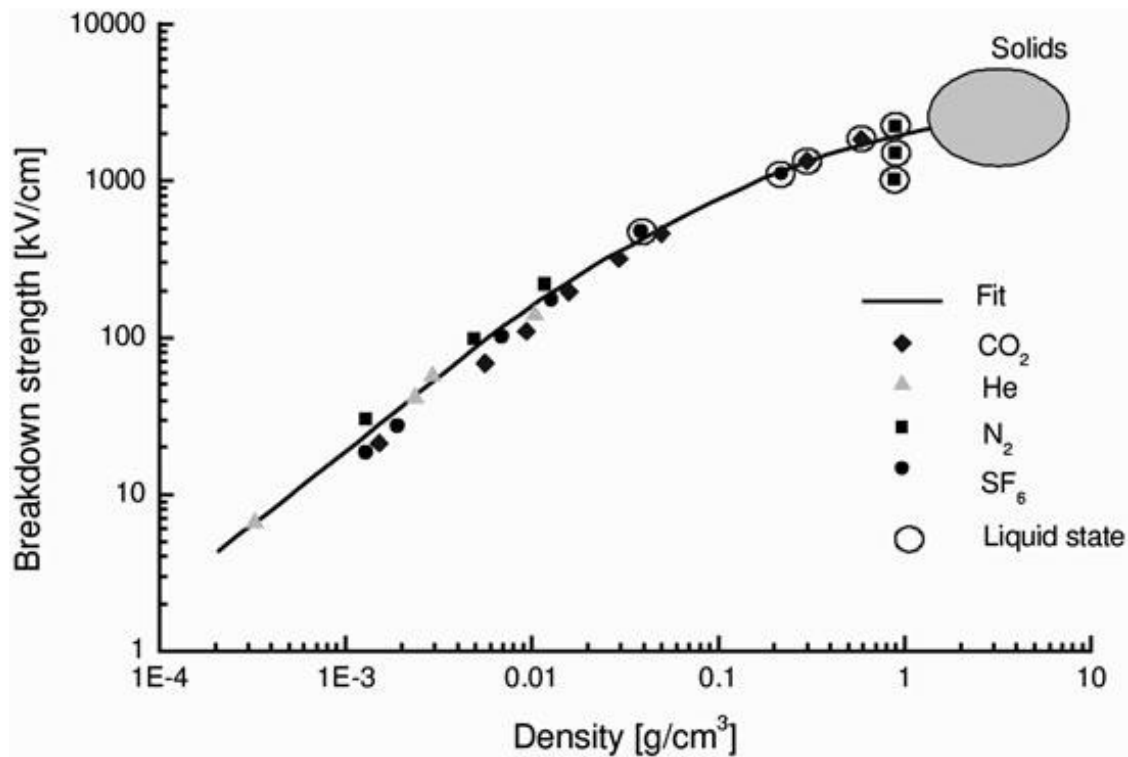

Breakdowns can happen in all states of materials



- **Gaseous or liquid dielectric – self-repairing after a breakdown.**
- **Solid dielectric – remains irreversibly destroyed.**
- **Liquid dielectric – preferred if large heat losses have to be removed since the heat capacity of liquid is larger than that of gas.**

Catatumbo Lightning



Outlines



- Introduction to pulsed-power system
- Review of circuit analysis
- **Static and dynamic breakdown strength of dielectric materials**
 - **Gas – Townsend discharge (avalanche breakdown), Paschen's curve**
 - Liquid
 - Solid
- Energy storage
 - Pulse discharge capacitors
 - Marx generators
 - Inductive energy storage

Static breakdown



- The electric strength of a gas is determined by the magnitude of its atomic and molecular reaction cross section.
- For electron collisions, there are ionization cross section and attachment cross section.

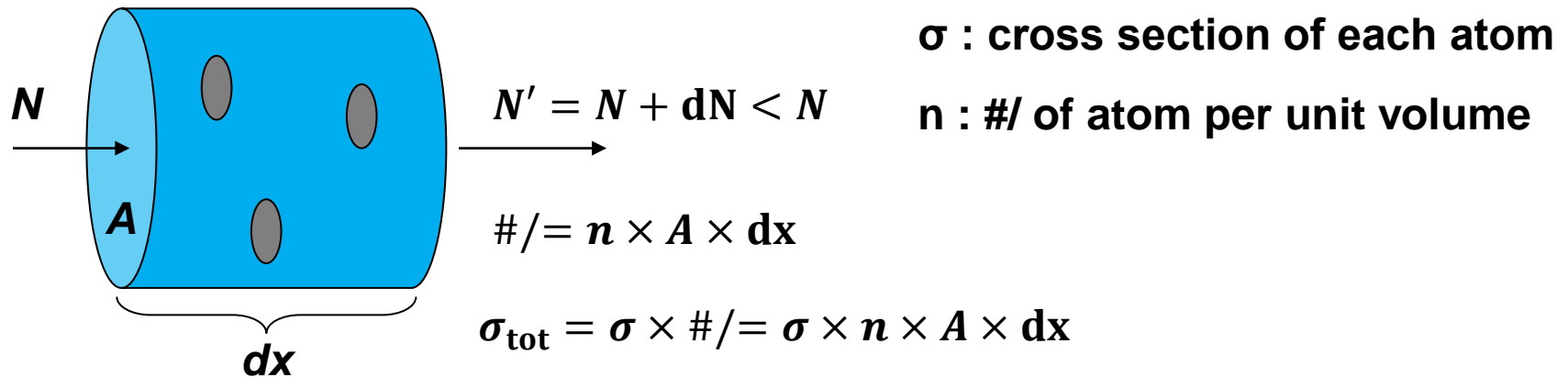

- Probability of a particle causing an interaction in this layer (dx):

$$P = \frac{\sigma_{\text{tot}}}{A} = \frac{\sigma n A dx}{A} = \sigma n dx \equiv \Sigma dx \qquad \Sigma \equiv \sigma \times n$$

Mean free path

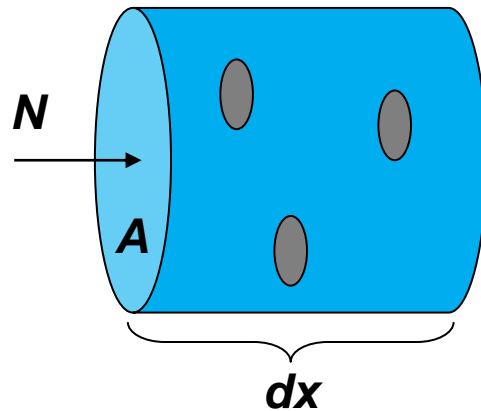

$$N' = N + dN < N$$

$$P = \frac{\sigma_{\text{tot}}}{A} = \frac{\sigma n A dx}{A} = \sigma n dx \equiv \Sigma dx$$

$$\# / = n \times A \times dx$$

$$\sigma_{\text{tot}} = \sigma \times n \times A \times dx$$

$$\Sigma \equiv \sigma \times n$$

$$dN = -NP = -\Sigma N dx \quad \frac{dN}{N} = -\Sigma dx \quad N(x) = N_0 e^{-\Sigma x}$$

- Mean free path – averaged length of a particle that can move without a collision.

$$\lambda = \frac{\sum_i N(x_i) x_i}{N_{\text{tot}}} = \frac{\int x dN'}{\int dN'} \stackrel{\uparrow}{=} \frac{1}{N_0} \int x \Sigma N(x) dx = \frac{\Sigma}{N_0} \int_0^{\infty} x N_0 e^{-\Sigma x} dx$$

$$dN' = -dN = \Sigma N dx$$

dN' : #/ of particles stay in $x \sim x+dx$

$$u = x \quad dv = e^{-\Sigma x} dx$$

$$du = dx \quad v = -\frac{1}{\Sigma} e^{-\Sigma x}$$

$$\lambda = \Sigma \left(-\frac{1}{\Sigma} x e^{-\Sigma x} \Big|_0^{\infty} + \frac{1}{\Sigma} \int_0^{\infty} e^{-\Sigma x} dx \right) = -\frac{1}{\Sigma} e^{-\Sigma x} \Big|_0^{\infty} = \frac{1}{\Sigma}$$

Kinetic energy needs to be greater than the ionization energy to ionize the gas



- Between each collision, the kinetic energy increases.

$$\lambda eE = \frac{1}{2} m v^2 \quad v = \sqrt{\frac{2eE\lambda}{m}}$$

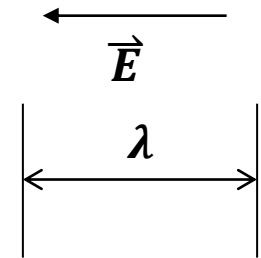

- Mean time between ionization collisions for electron with velocity v :

$$\tau = \frac{\lambda}{v}$$

- The rate of ionization is:

$$\frac{1}{\tau} = \frac{v}{\lambda} = \Sigma v$$

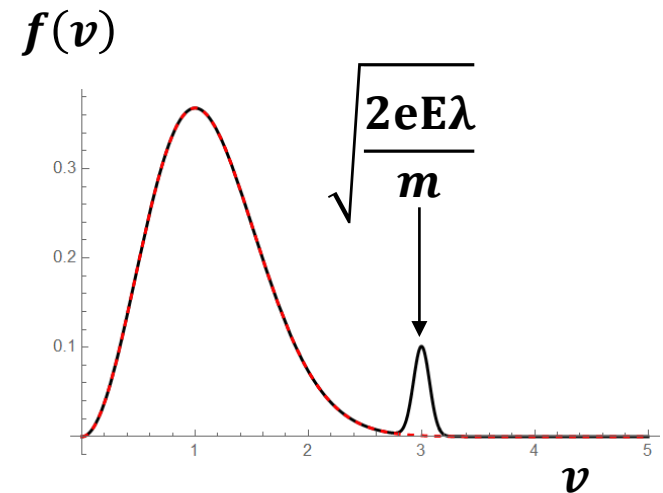

Collisions can be elastic or inelastic



- **Elastic collisions – NO energy exchanges. Momentum is redistributed.**

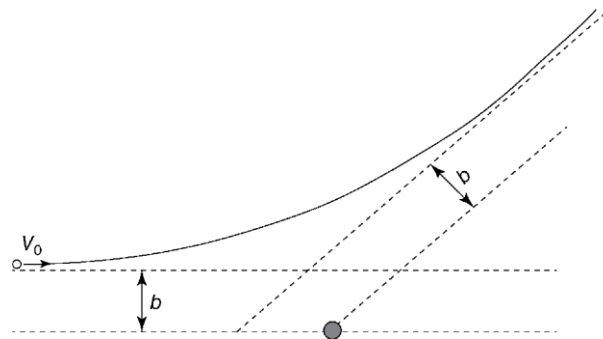

- **Inelastic collisions – energy is exchanged between the collision partners
→ production of molecules & particles.**
 - **A portion of the kinetic energy before collision is converted to potential energy of one of the particles in the system.**
 - **Ionization: $A + B \rightarrow A + B^+ + e^-$**
 - **The process of ionization is dominated by e^- acceleration in an electric field and is greatly aided by the appearance of initiatory electrons: (1) ionization in the gas; (2) emission from the cathode.**

Electron impact ionization is the most important process in a breakdown of gases



- Electron impact ionization: $A + e^- \rightarrow A^+ + e^- + e^-$
 - The most important process in the breakdown of gases but is not sufficient alone to result in the breakdown.

$$eE\lambda_{e,i} \geq eV_i \quad V_i: \text{ionization potential}$$

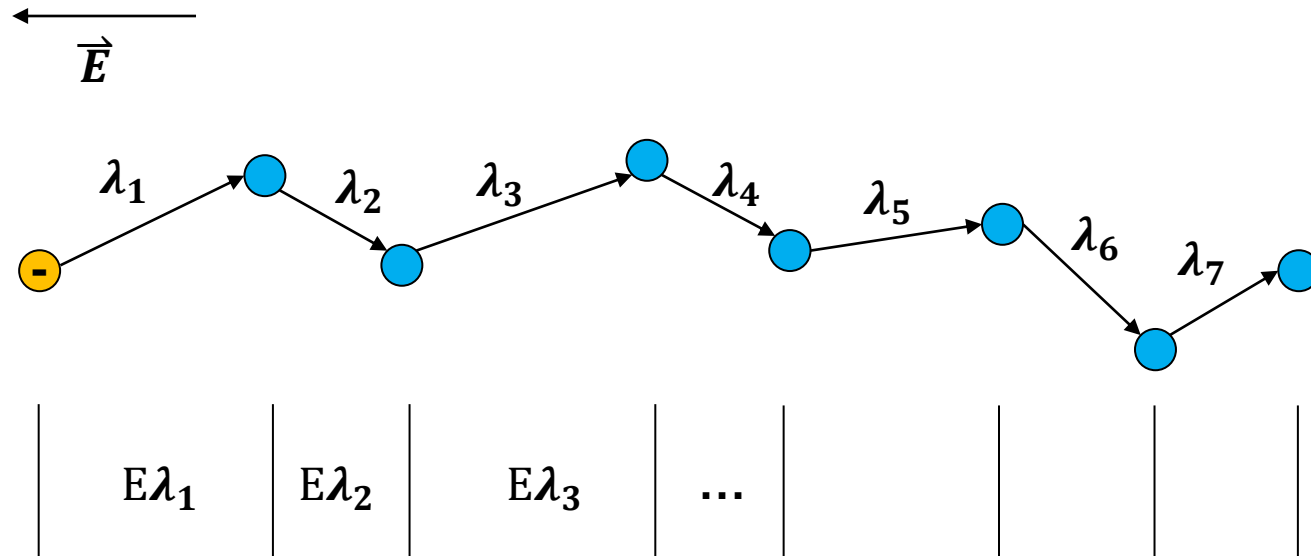

Photoionization & collisions with excited molecules



- **Metastable production (1~10 ms life time):** $A + B \rightarrow A^* + B$
- **Electron impact excitation:** $A + e^- \rightarrow A^* + e^-$
- **Step ionization:** $A^* + e^- \rightarrow A^+ + e^- + e^-$

- **De-excitation:** $A^* + e^- \rightarrow A + e^- + h\nu$
- **Radiative recombination:** $A^+ + e^- \rightarrow A + h\nu$

- **Dielectronic excitation:** $A^* + e^- \rightarrow A^{**} + e^-$
- **Autoionization:** $A^{**} \rightarrow A^+ + e^-$
- **Dielectronic recombination:** $A^{**} \rightarrow A + h\nu$

- **Step photoionization:** $A^* + h\nu \rightarrow A^+ + e^-$
- **Photoionization:** $A + h\nu \rightarrow A^+ + e^-$

Photoionization is very complex



- **Photons with $\lambda=125$ nm (UV) @ 9.9 eV can ionize almost all gases despite that almost all molecules and atom have ionization energy > 9.9 eV!**
- **Dust or water vapor can emit electrons through photon absorption.**
- **All photoionization occurs between 6~ 50 eV.**

Penning ionization – breakdown voltage may reduced with mixture of inert gas



- $A^* + B^* \rightarrow A^+ + B + e^-$
- May be from impurities or engineered mixture called penning mixture.
- A penning mixture is a mixture of an inert gas with a small amount of a quench gas, which has lower ionization potential than the 1st excited state of the inert gas.
- Ex: neon lamp: Ne + Ar (<2%)

plasma display: He/Ne + Xe

Gas ionization detector: Ar/Xe, Ne/Ar, Ar/acetylene(乙炔)

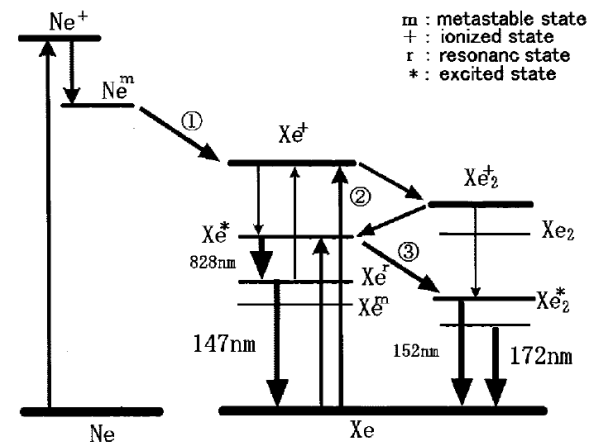
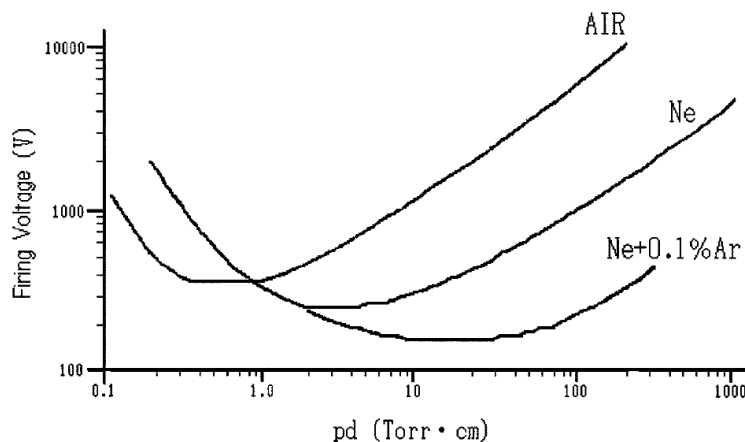

More complex collisions



- 3-body collision: $A^+ + e^- + e^- \rightarrow A^* + e^-$
- Ion impact excitation: $A^+ + B \rightarrow A^+ + B^*$
- 3-body collision: $A^+ + B + e^- \rightarrow A^* + B$
- Ion impact ionization: $A^+ + B \rightarrow A^+ + B^+ + e^-$

- Total collisional cross section:

$$\sigma(v) = \sigma_{el} + \sigma_{ex} + \sigma_{ion} + \dots = \sum_i \sigma_i$$

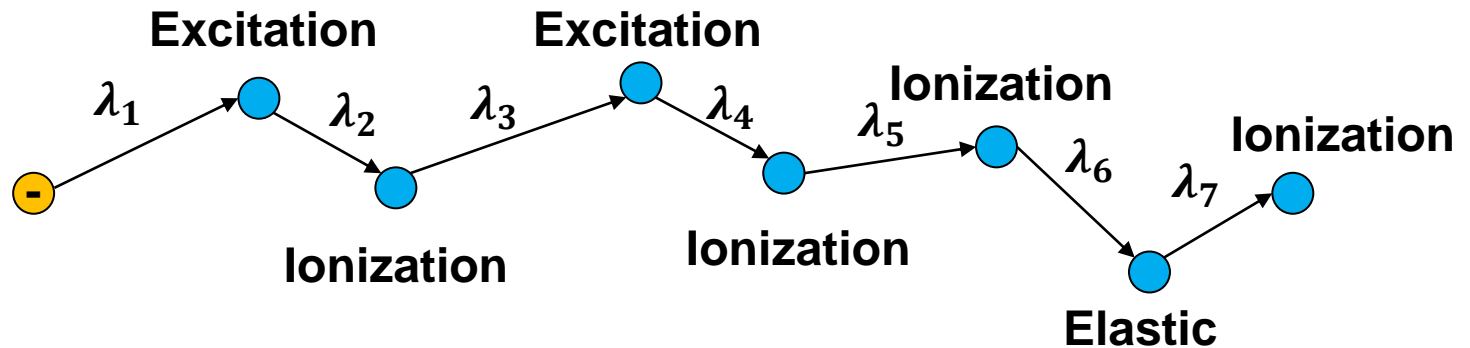

- Inert gas can be ionized easier since there are less exciting state compared to gas molecular.
- Molecular that may absorb electrons is harder to be ionized, i.e., has higher dielectric strength. Ex: SF_6 , O_2 , etc.

Breakdown voltage of different gas

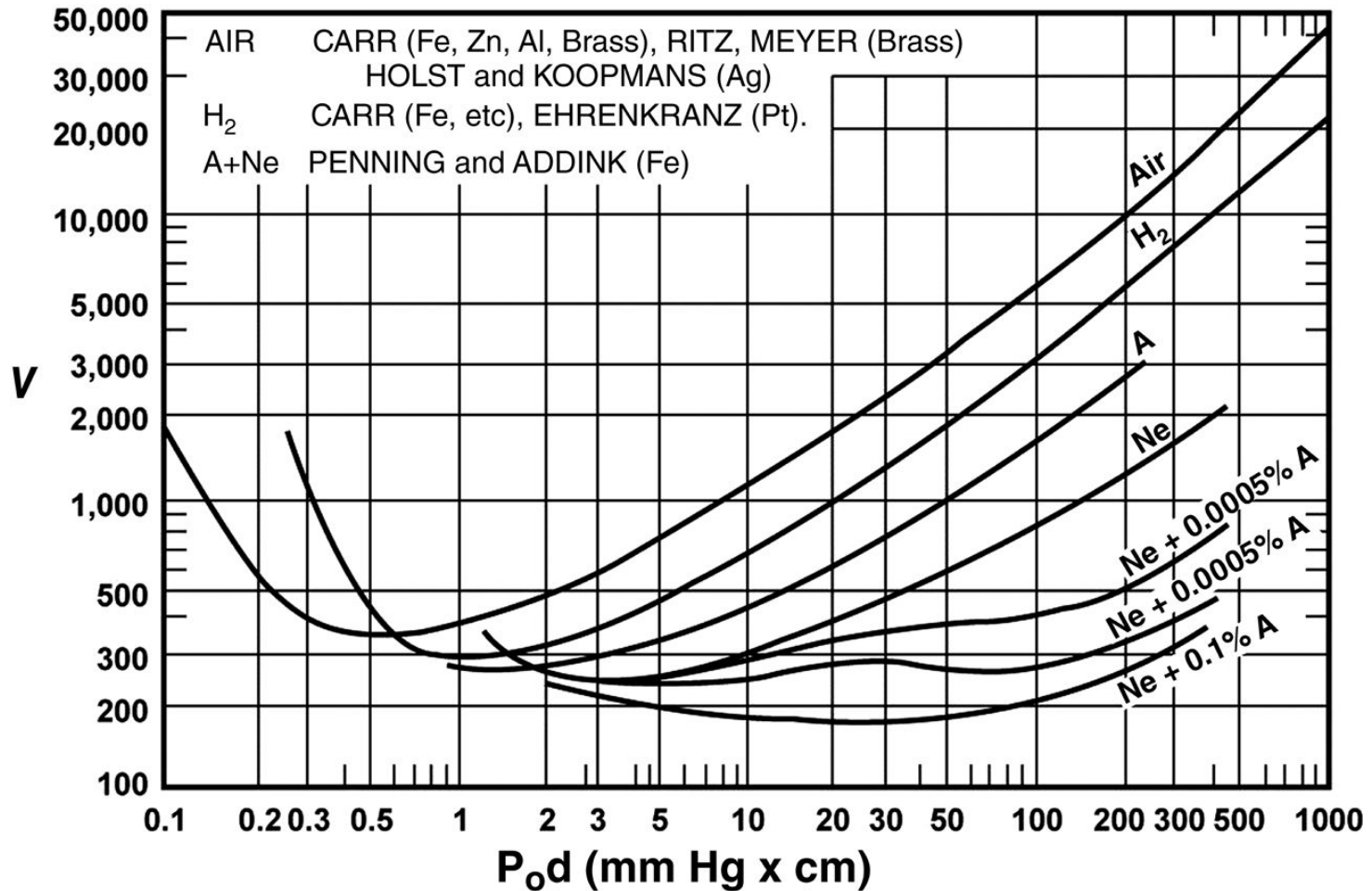

Electric breakdown – Townsend's experiments

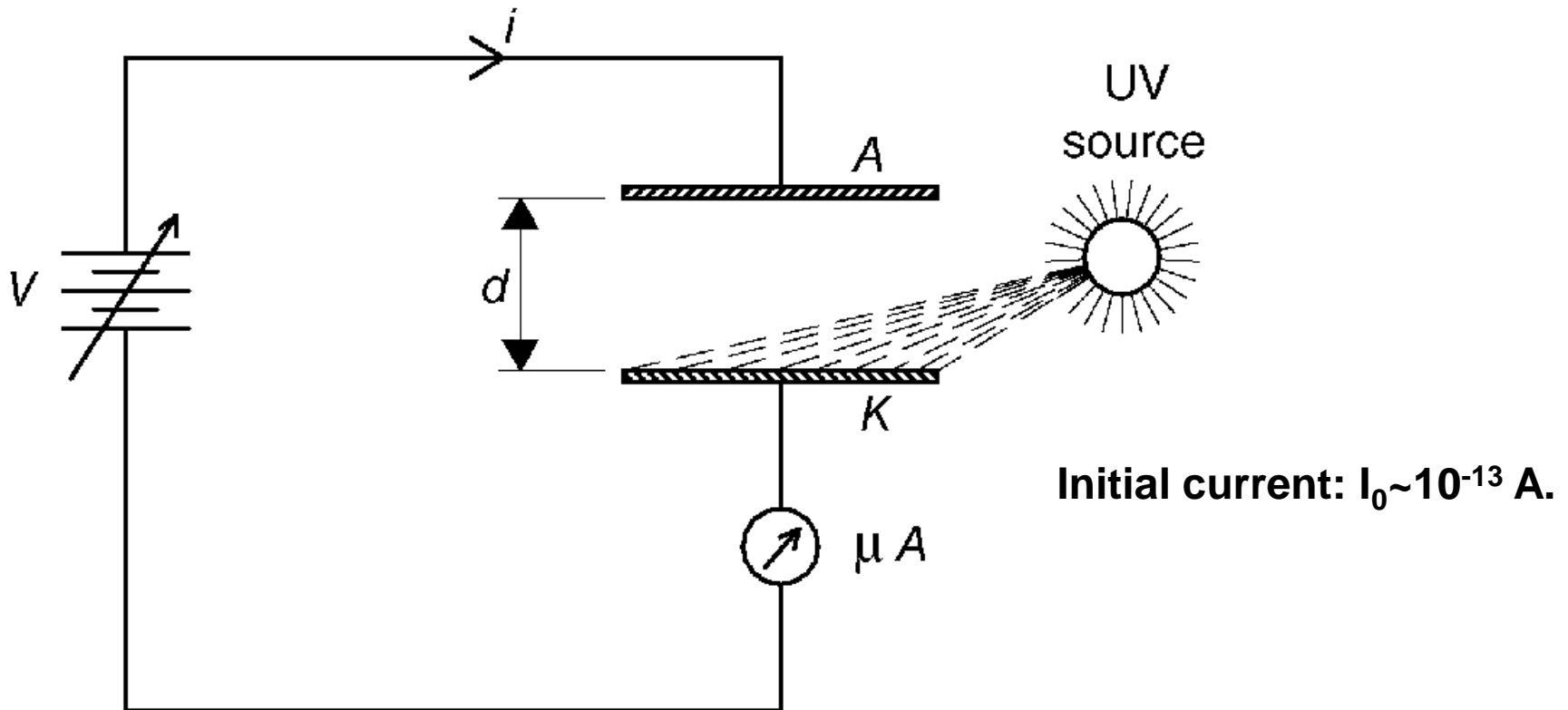

- Initial current can be generated by the static charge on electrode or gas.
- With higher voltage, high current is induced. A spark is produced eventually.

Current grows with a higher voltage



- Photoemission from UV or static charges emitted from electrodes.

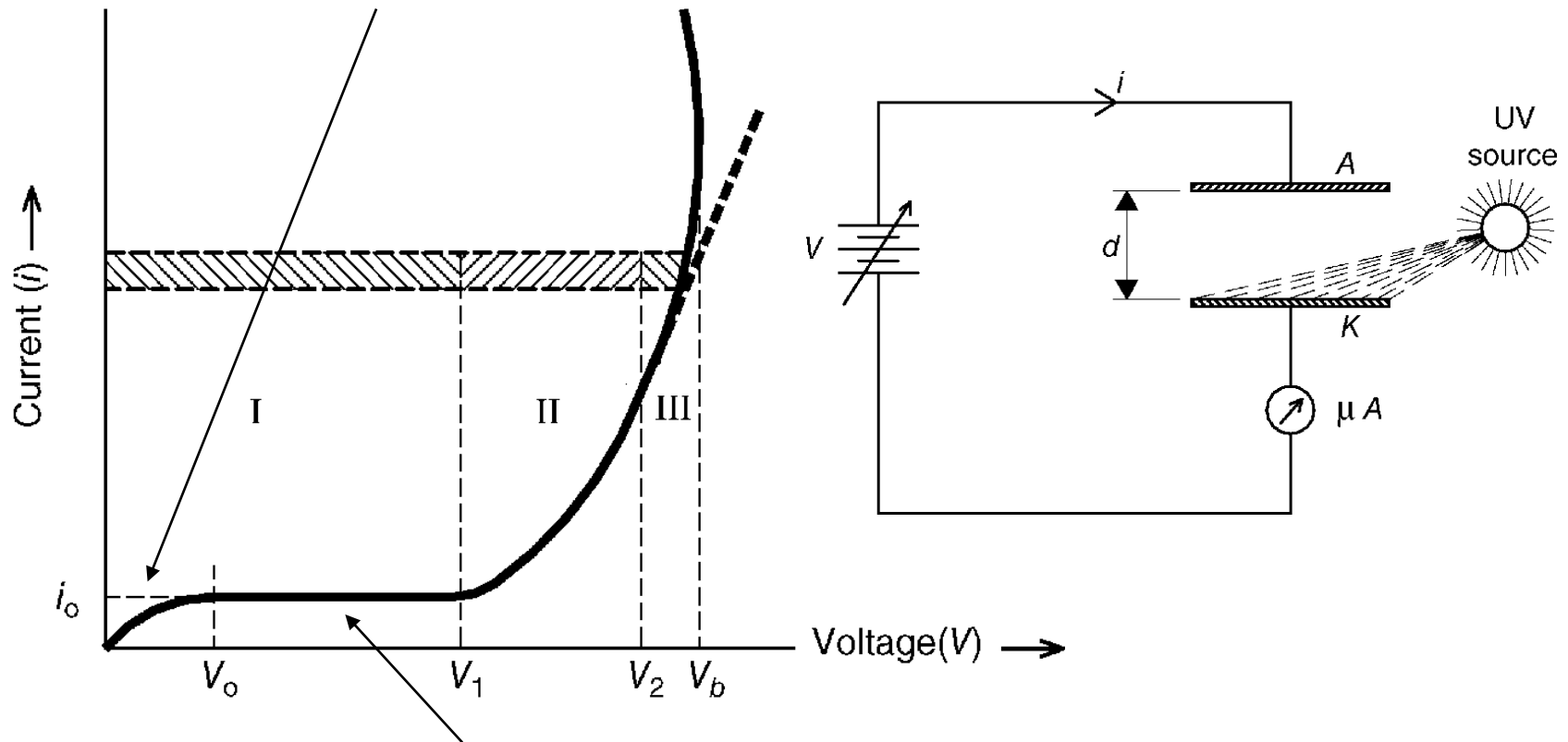

- Electrons emitted from cathode are scattered in random directions colliding with gas molecules.
- The directed averaged drift velocity $>$ average random velocity component.

Section II: the Townsend 1st ionization region



- The current increases exponentially with gap distance.

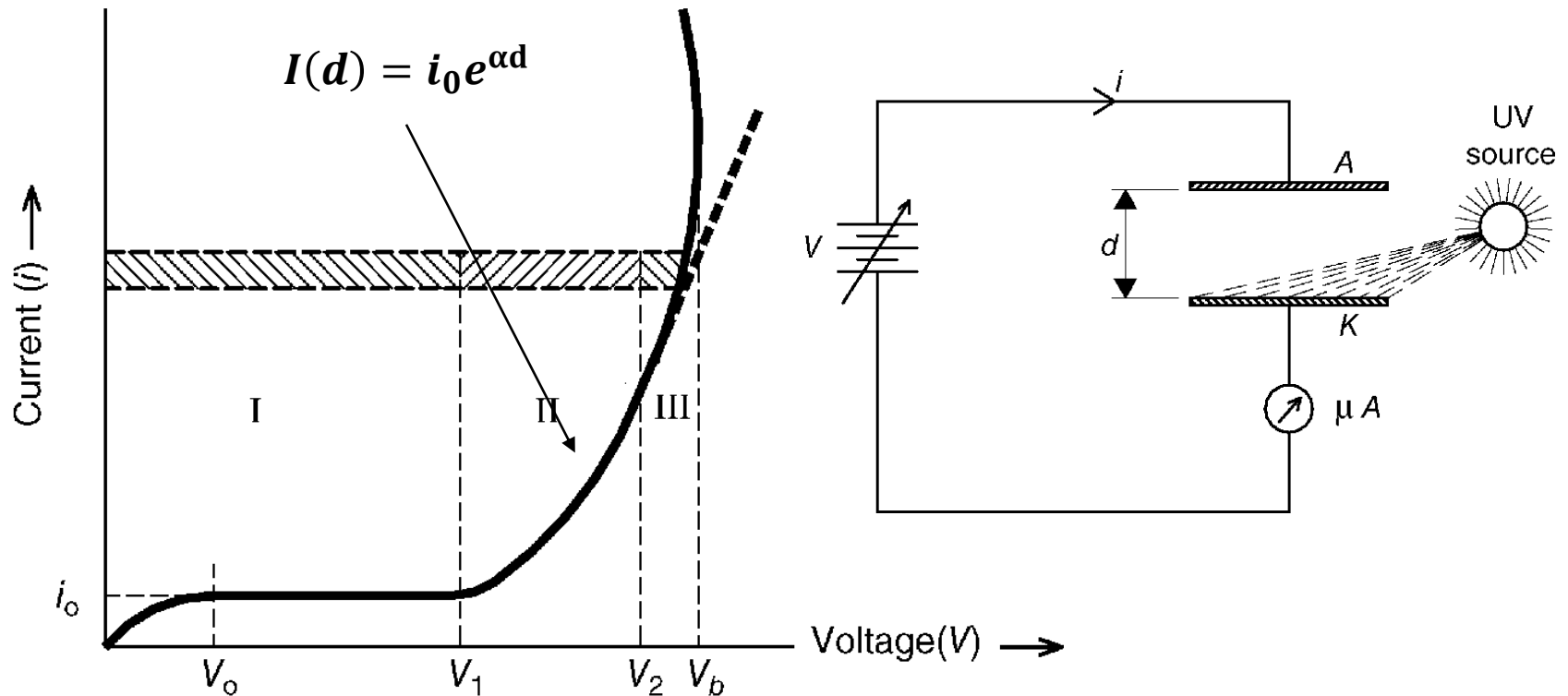

Section III: the Townsend 2nd ionization region



- Single-electron avalanche is not sufficient to carry the circuit-limited current.
- Successor avalanches are formed by positive ions, resulting from ionization collisions with primary electrons, bombarding cathode and liberating more electrons.

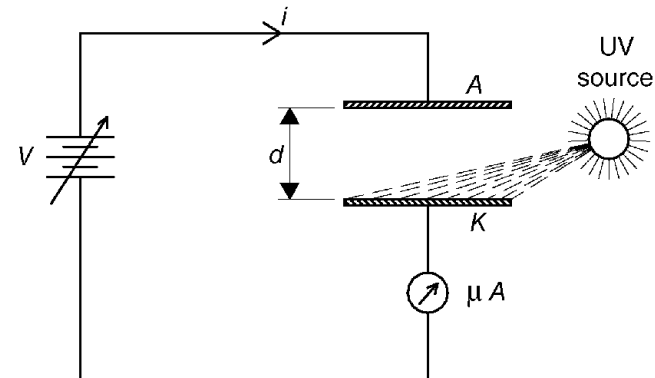
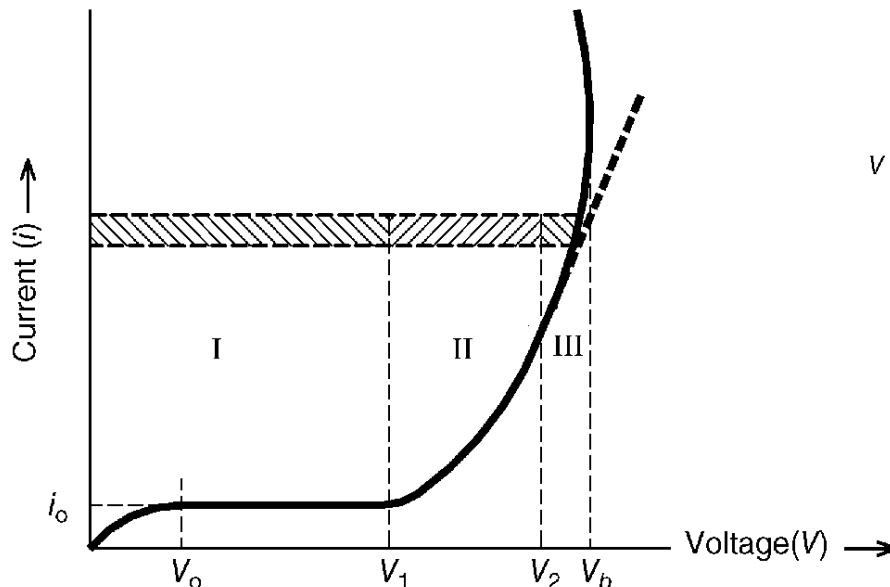

Electron Avalanche: a cascade ionization initiated by a single electron in a uniform electric field



- Present naturally, or photon, or cosmic rays, or static charge.

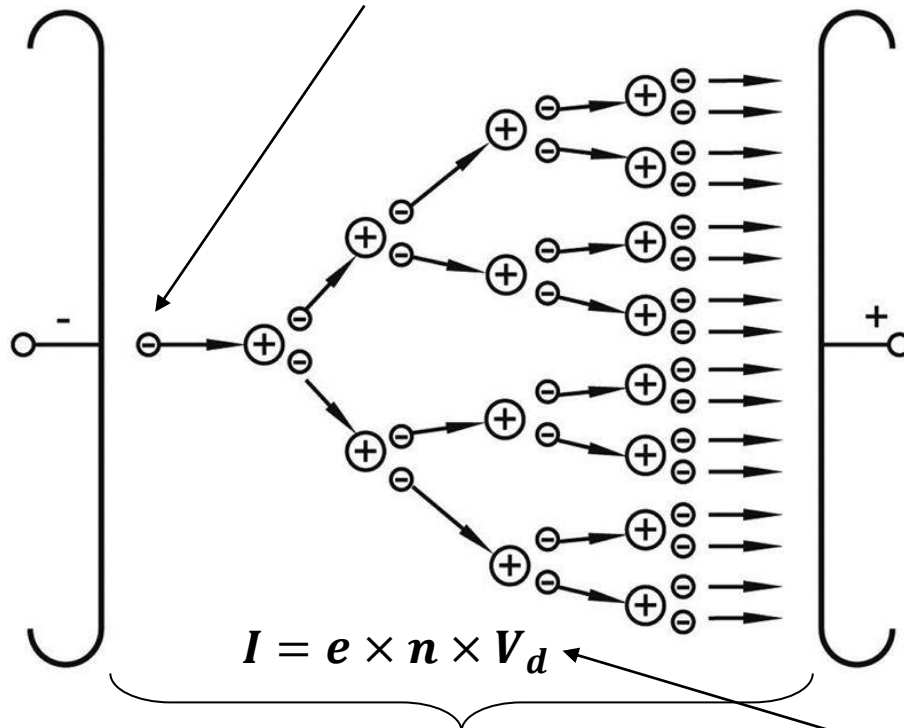

- Cascade ionization

V_d : drift velocity of electrons

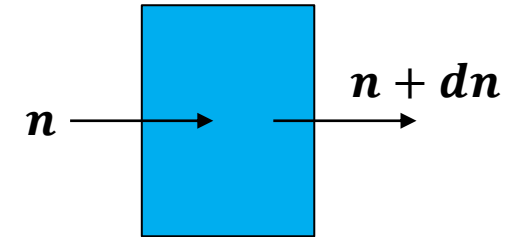

$$dn = n(x)\alpha dx$$

$$\int \frac{dn}{n} = \alpha \int dx$$

$$n(x) = n_0 e^{\alpha x}$$

$$I(d) = i_0 e^{\alpha d}$$

α : Townsend's 1st ionization coefficient

#/ of ionization events performed by an electron in a unit length.

Notice that α/p is a unique function of E/p where p is the gas pressure under normal conditions

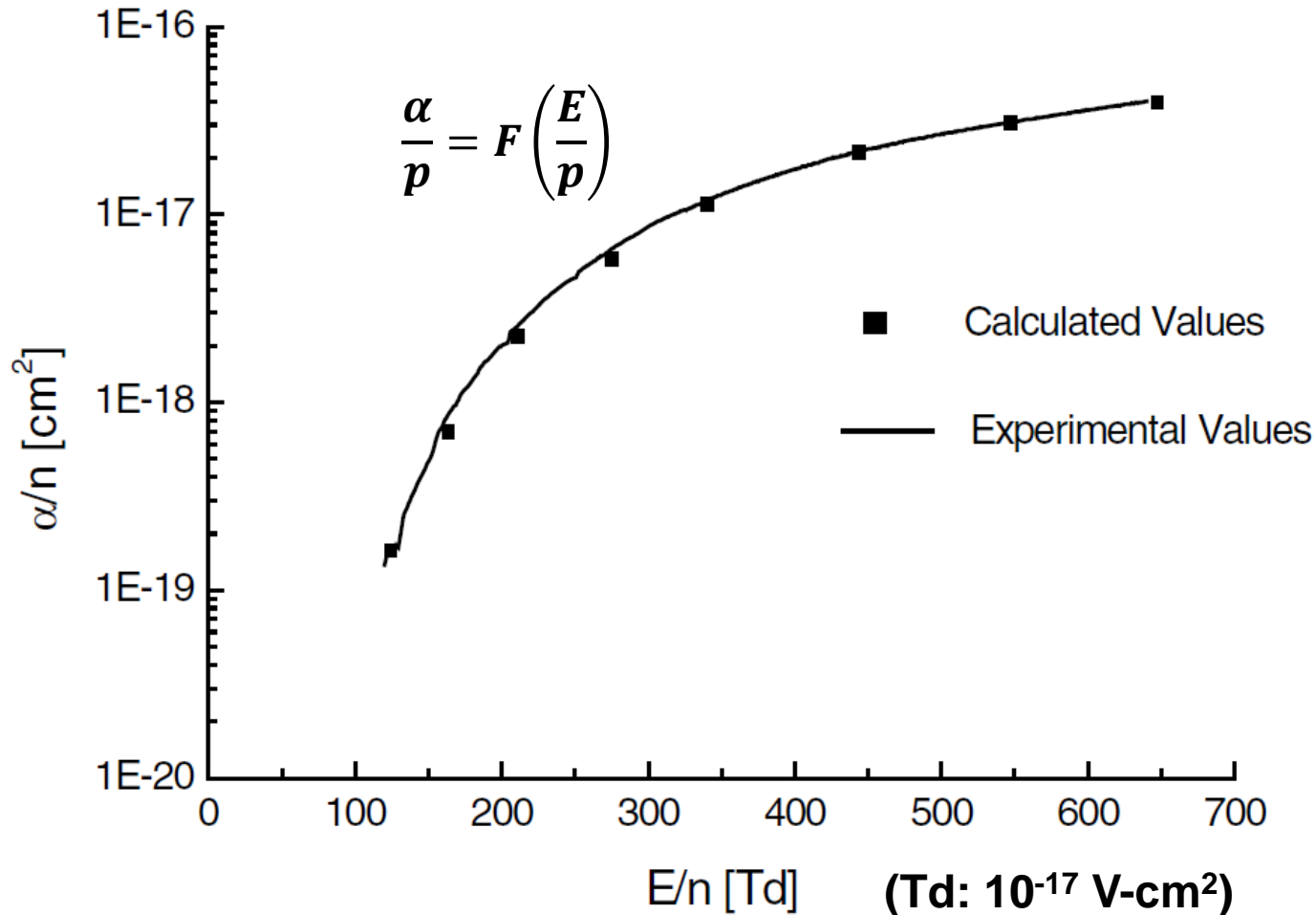

More electrons, secondary electrons, are needed to cause the breakdown



- Secondary electrons – electrons released from the cathode by ions that have drifted to the electrode as well as by light quanta created by recombination and de-excitation processes.

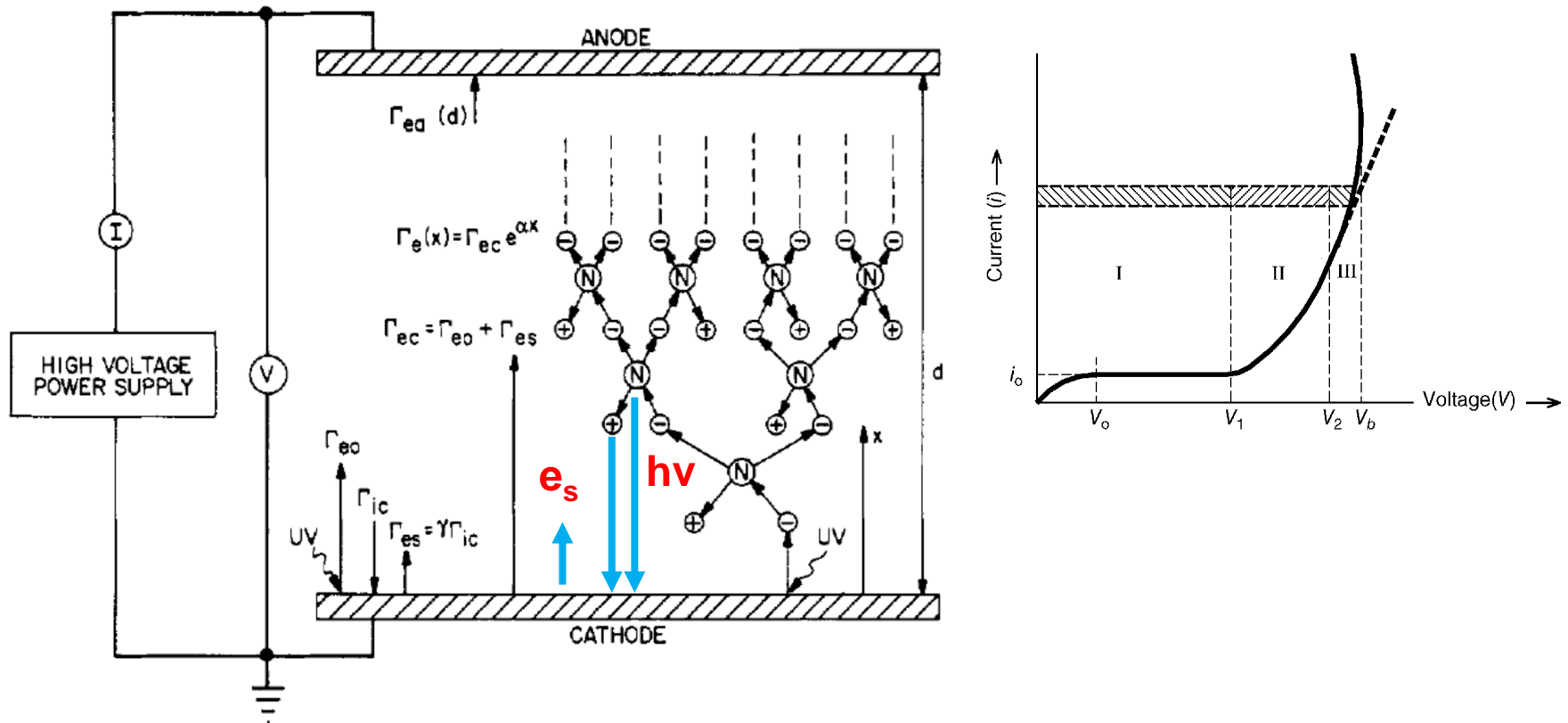

Secondary electrons lead to more electron avalanche



$$\begin{aligned}
 n(0) &= n_0 + \omega \int_0^d n(x) dx \\
 &= n_0 + \omega n(0) \int_0^d e^{\alpha x} dx \\
 &= n_0 + \omega n(0) \frac{1}{\alpha} e^{\alpha d} \Big|_0^d
 \end{aligned}$$

$$n(0) = n_0 + \frac{\omega}{\alpha} n(0) (e^{\alpha d} - 1)$$

$$n(0) = \frac{n_0}{1 - \frac{\omega}{\alpha} (e^{\alpha d} - 1)}$$

$$n(d) = \frac{n_0 e^{\alpha d}}{1 - \frac{\omega}{\alpha} (e^{\alpha d} - 1)}$$

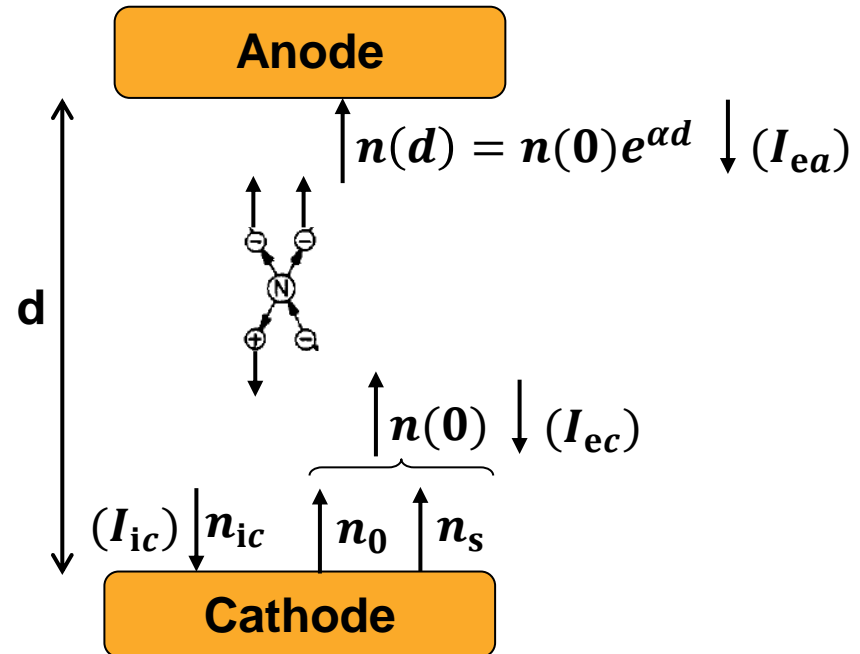

- n_0 : the #/ of electrons released from the cathode by external process.
- ω : coefficient of generating secondary electrons from the #/ of total generated primary electrons.

Secondary electrons generation are strongly dependent on the cathode material



- Multiple secondary electron mechanism:

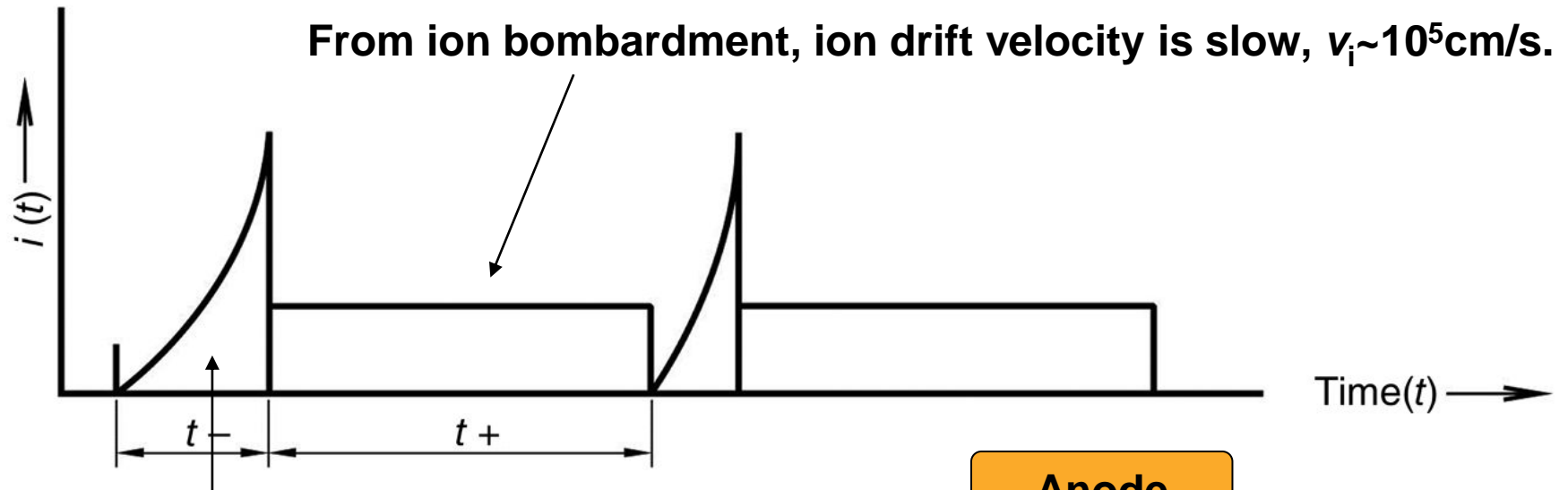

From photon, $v \sim 10^{10} \text{ cm/s}$.

- Time it takes for a breakdown is $\sim d/v_i$.

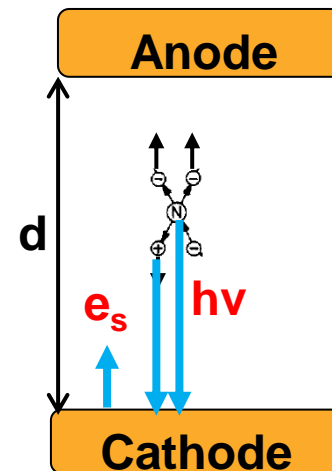

Townsend condition for ignition



- When the denominator equals to zero, the breakdown happens.

$$n(d) = \frac{n_0 e^{\alpha d}}{1 - \frac{\omega}{\alpha} (e^{\alpha d} - 1)}$$

$$1 - \frac{\omega}{\alpha} (e^{\alpha d} - 1) = 0 \qquad \frac{\omega}{\alpha} (e^{\alpha d} - 1) = 1$$

- The insulation of the cathode-anode gap breaks down and a self-sustained discharge is created.

- Experiments show that ω/p is also a function of E/p , i.e., $\frac{\omega}{p} = f\left(\frac{E}{p}\right)$

$$\frac{\omega/p}{\alpha/p} (e^{\frac{\alpha}{p} pd} - 1) = 1 \qquad \frac{f(E/p)}{F(E/p)} (e^{F(E/p)pd} - 1) = 1 \qquad E = \frac{V}{d} \qquad \frac{E}{p} = \frac{V}{pd}$$

- V can be solved for given pd if $f(E/p)$ and $F(E/p)$, i.e., $f(V/pd)$ and $F(V/pd)$ are known.

Paschen's law: the breakdown voltage V_b of a uniform-field gap is a unique function Π of pd



$$V_b = \Pi(pd)$$

- In certain region, A and B are constants for a given gas.

$$\frac{\alpha}{p} = Ae^{-BP/E} \equiv Ae^{-B\frac{pd}{V}} \quad \gamma \equiv \frac{\omega}{\alpha} = \frac{f(E/p)}{F(E/p)} = \gamma\left(\frac{E}{p}\right)$$

- Γ is a slowly varying function of E/p over a wide range.

$$\frac{\omega}{\alpha}(e^{\alpha d} - 1) = 1$$

$$\gamma(e^{\alpha d} - 1) = 1$$

$$\gamma\left(e^{\frac{\alpha}{p}pd} - 1\right) = 1$$

$$\frac{\alpha}{p}pd = \ln\left(1 + \frac{1}{\gamma}\right)$$

$$Ae^{-B\frac{pd}{V}} = \frac{\ln\left(1 + \frac{1}{\gamma}\right)}{pd} \quad e^{B\frac{pd}{V}} = \frac{Apd}{\ln\left(1 + \frac{1}{\gamma}\right)}$$

$$\frac{Bpd}{V} = \ln\left[\frac{Apd}{\ln\left(1 + \frac{1}{\gamma}\right)}\right]$$

$$V_B = \frac{Bpd}{\ln\left[\frac{Apd}{\ln\left(1 + \frac{1}{\gamma}\right)}\right]}$$

Paschen's curve



Gas	A(1/mm-bar)	B(kV/mm-bar)	Range of E/p for validity (kV/mm-bar)
Air	1130	27.4	11-45
N ₂	977	25.5	8-45
H ₂	376	9.8	11-30
He	210	2.6	2-11
Ar	1020	13.5	8-45
CO ₂	1500	34.9	37.75

$$V_B = \frac{Bpd}{\ln \left[\frac{Apd}{\ln \left(1 + \frac{1}{\gamma} \right)} \right]}$$

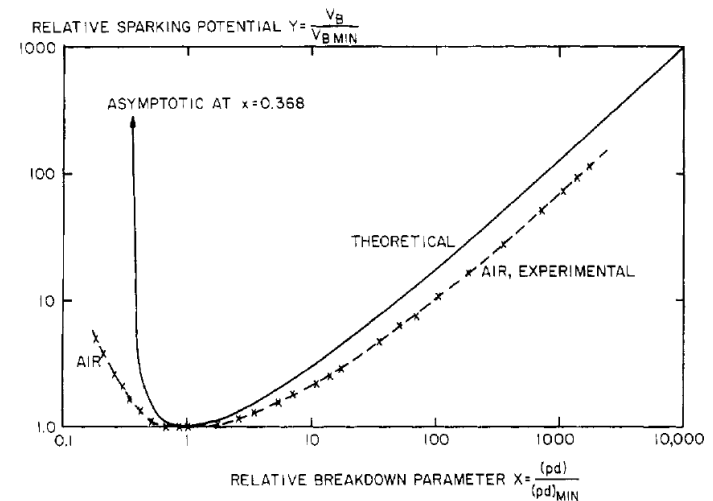

Paschen's curve



$$V_B = \frac{Bpd}{\ln \left[\frac{Apd}{\ln \left(1 + \frac{1}{\gamma} \right)} \right]} \quad x \equiv pd \quad C \equiv \ln \left(1 + \frac{1}{\gamma} \right) \quad V_B = \frac{Bx}{\ln(Ax/C)}$$

$$\frac{dV_B}{dx} = \frac{B \ln \left(\frac{Ax}{C} \right) - Bx \frac{A/C}{Ax/C}}{\left(\ln \left(\frac{Ax}{C} \right) \right)^2} = \frac{B \left[\ln \left(\frac{Ax}{C} \right) - 1 \right]}{\left(\ln \left(\frac{Ax}{C} \right) \right)^2} \equiv 0 \quad \ln \left(\frac{Ax}{C} \right) - 1 = 0 \quad x = e \frac{C}{A}$$

$$pd_{min} = e \frac{\ln \left(1 + \frac{1}{\gamma} \right)}{A}$$

$$V_{B,min} = \frac{Bx}{\ln \left(e \frac{C}{A} \frac{A}{C} \right)} = \frac{Bx}{\ln e} = Bx = eC \frac{B}{A}$$

$$V_{B,min} = e \ln \left(1 + \frac{1}{\gamma} \right) \frac{B}{A}$$

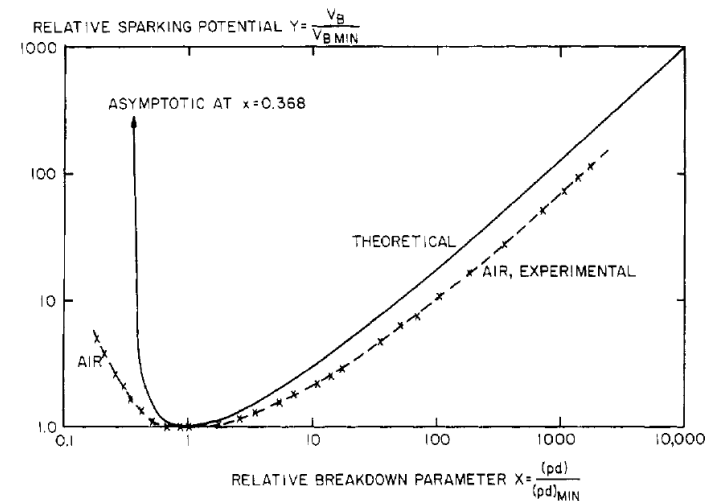

With a voltage lower than $V_{B,min}$ it is impossible to cause the breakdown of a gap with a uniform field

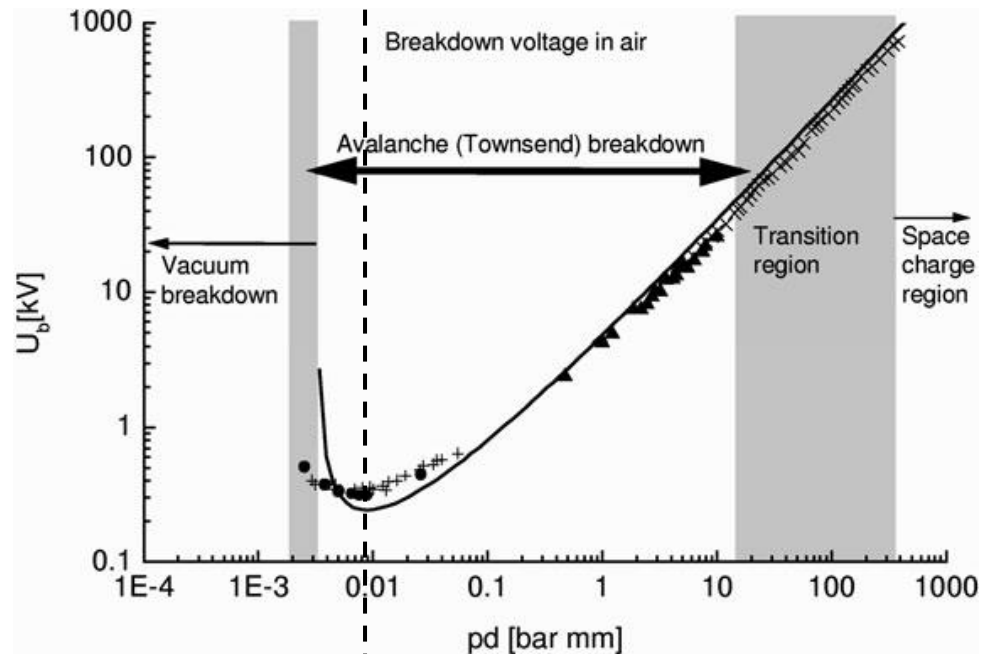

- Collision is not frequent enough even the electrons gain large energy between each collision.
- The minimum of the Paschen's curve corresponds to the Stoletow point, the pressure at which the volumetric ionization rate is a maximum.
- Electrons do not gain enough energy between each collision even collisions happen frequently.

At very high field strengths, field emission of electrons from the electrodes occurs (far left or right of the curve)

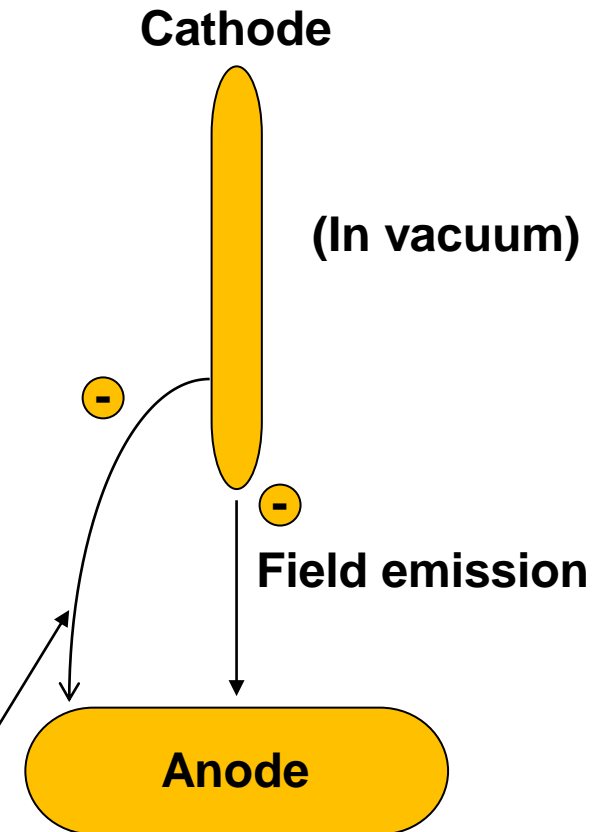
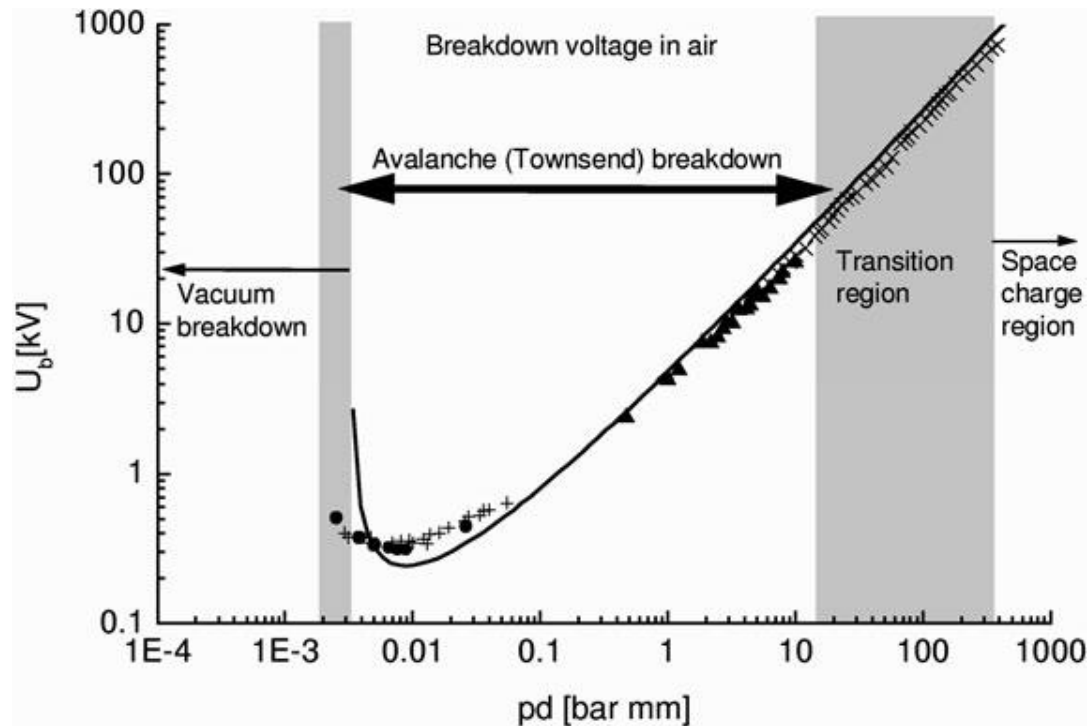

Longer path but more dangerous!

The most commonly used high-strength gas is SF₆

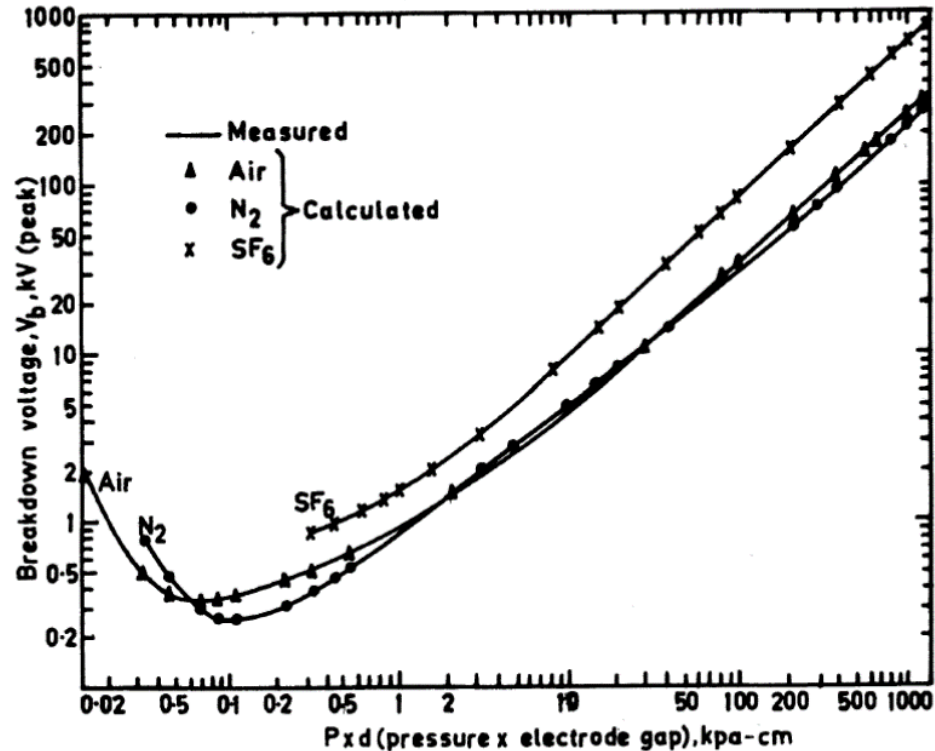

- SF₆ belongs to a group of “electronegative gases,” which are characterized by the ability to attach electrons to the molecule, which then becomes a “negative ion.”
- O₂ has similar effect.

Breakdown voltage is affected by the geometry of the electrodes

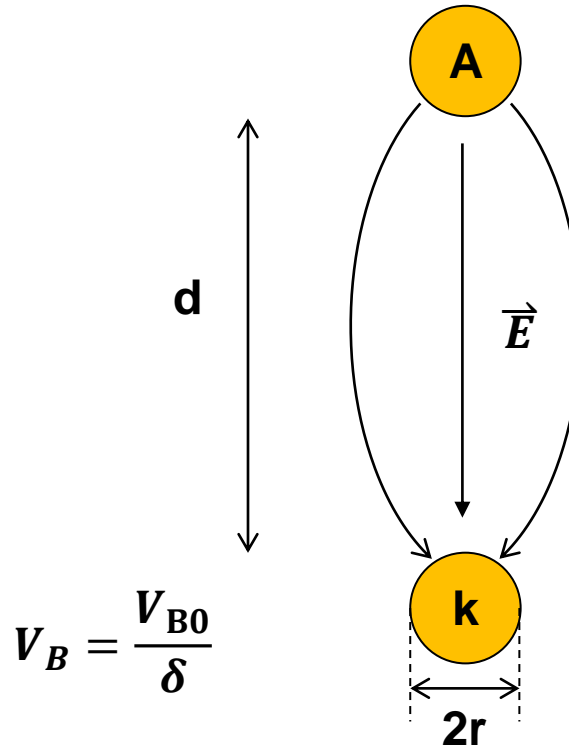
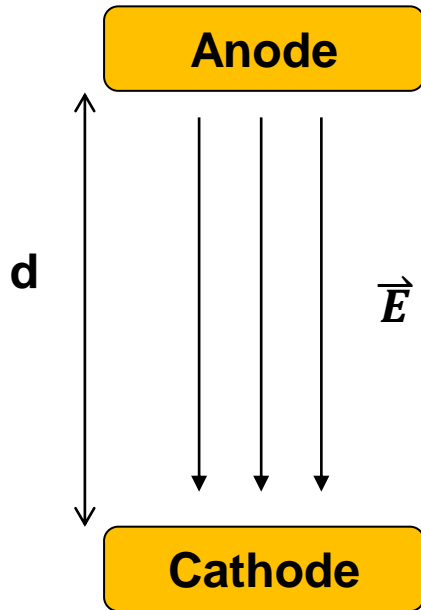

$$V_B = \frac{V_{B0}}{\delta}$$

$$\delta = \frac{x}{2r} \quad x \equiv d - 2r \gg r$$

$$\delta \sim \frac{x}{2r \ln(x/r)} \quad x \equiv d - 2r \gg r$$

$$\delta = \frac{\frac{R}{r} - 1}{\ln(R/r)}$$

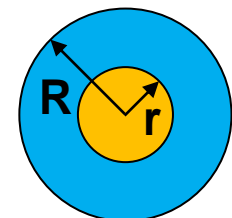

- Equal spheres:
- Equal parallel cylinders:
- Concentric cylinders:

For $E_{\text{needle}} > E_{\text{flat}}$

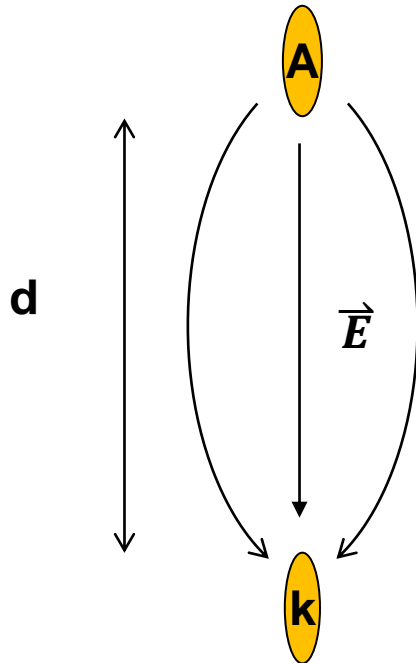

$$V_B = \left(\frac{E}{p}\right)_0 \text{pd}_{\text{eff}} + C(\text{pd}_{\text{eff}})^{1/2}$$

- D_{eff} : it is defined as the distance where the field has dropped to about 80% of its maximum value.

Paschen's curve is used to design different high voltage high current switches in pulsed-power system



- Pulsed-power system

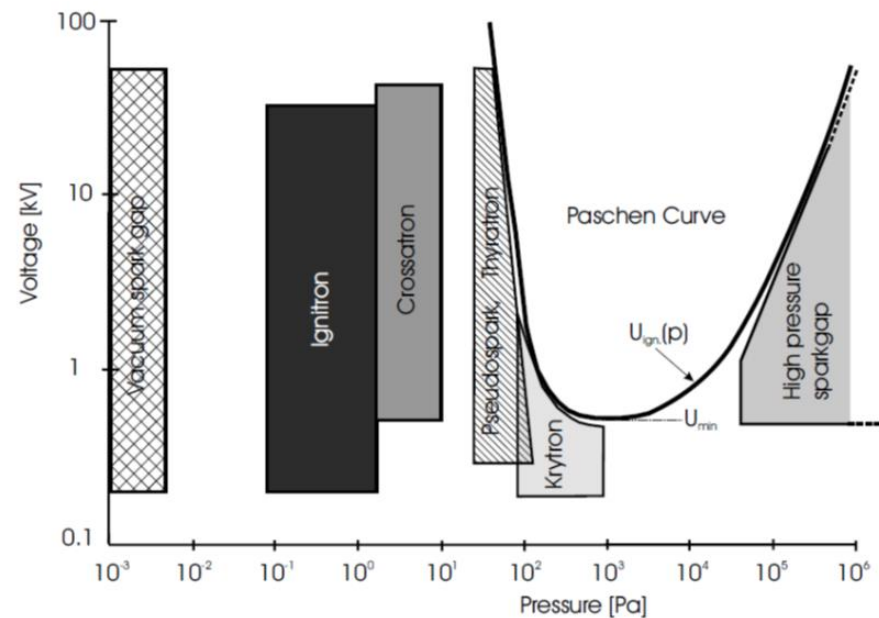
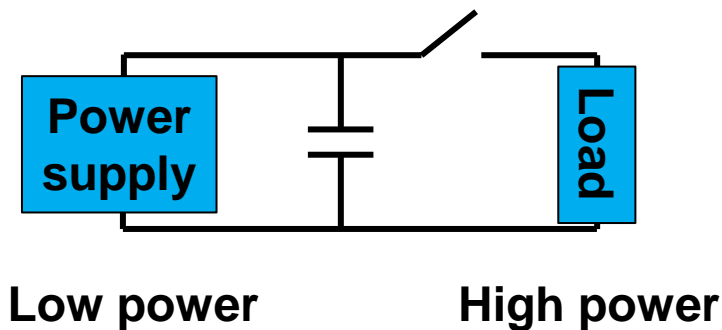

A spark gap switch is closed when electron breakdown occurs

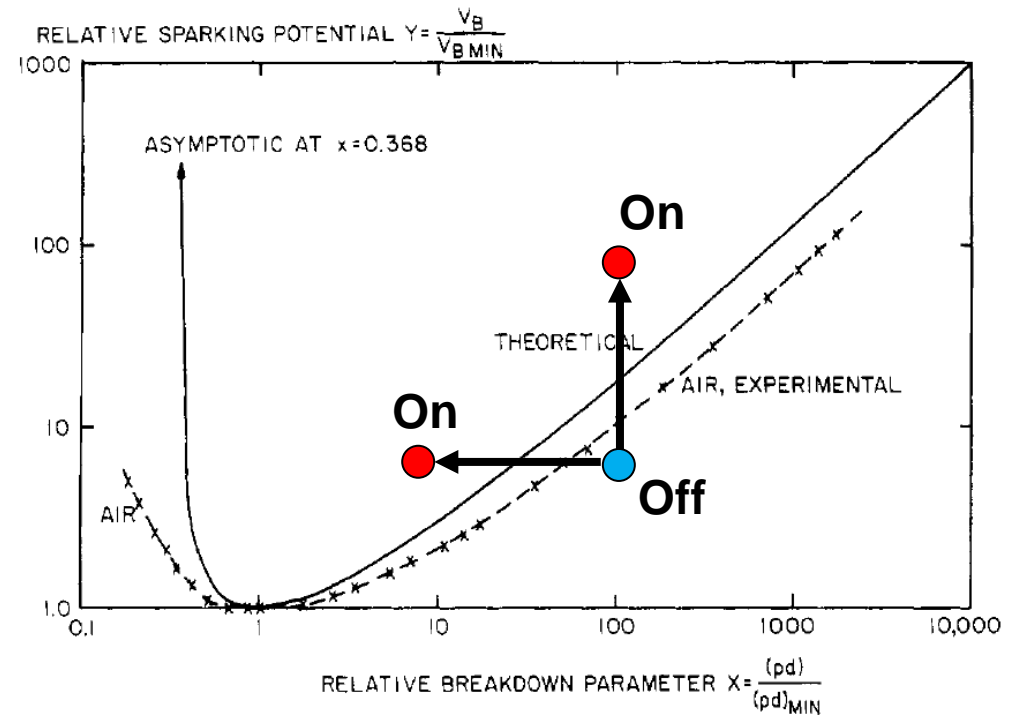
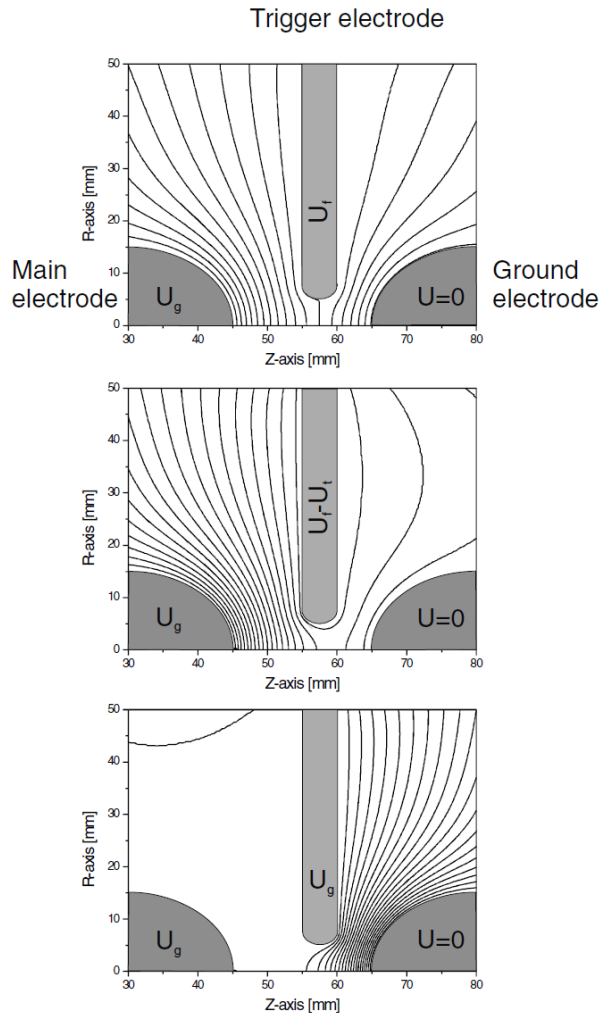

Space charge effect

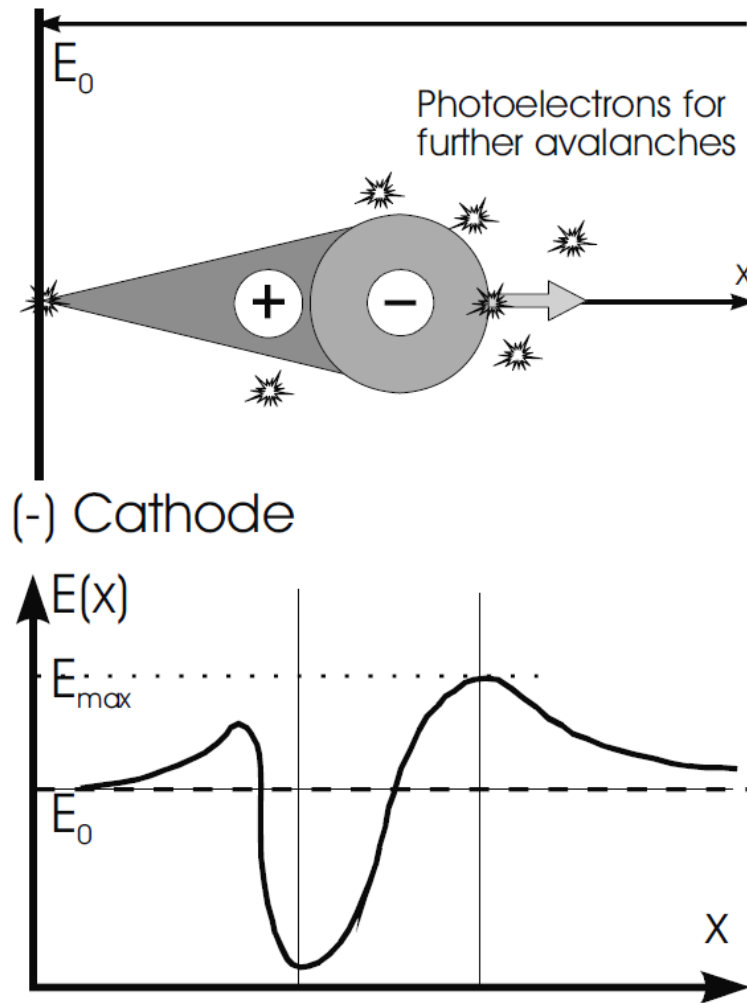

For long, atmospheric air gaps, the discharge time can't be explained by using Townsend's model



- Ex1: $d \sim 1 \text{ cm}$, short delay time ($< 1 \mu\text{s}$)

For Townsend's model, successive avalanche is determined by ion drift velocity:

$$\Delta t \sim \frac{1 \text{ cm}}{10^5 \text{ cm/s}} \sim 10 \mu\text{s}$$

- Ex2: breakdown appears to be independent of cathode material.
- Ex3: Townsend's discharges are developed mostly from the cathode. However, existence of narrow, luminous discharges originating from either the anode or from the middle of the gap may happen!

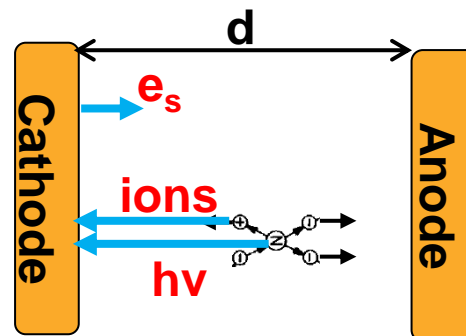

Electrons moving much faster than ions leads to space charge effort which will enhance the avalanche

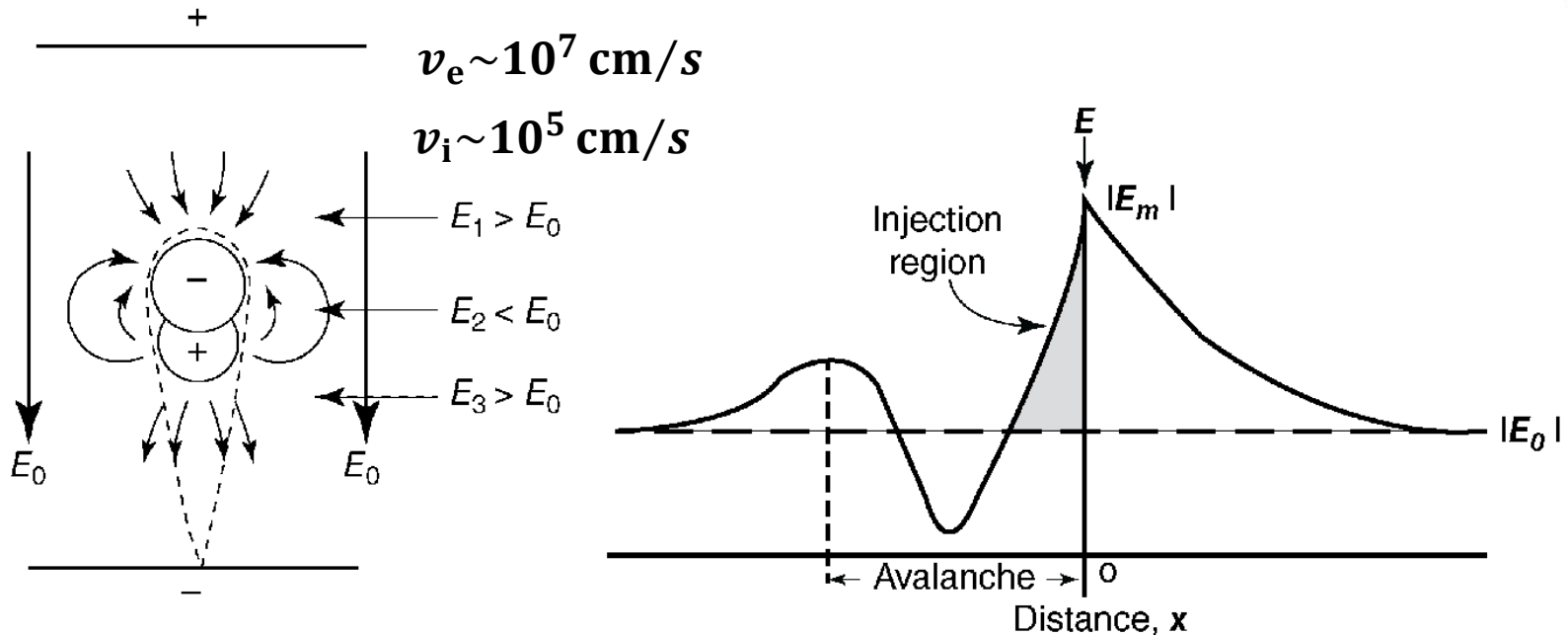

- **Criterion for streamer onset:**

$E_r \sim E_0$ where E_r is generated by the space charge at the head of the avalanche.

or $N_{cr} \sim 10^8$ where N_{cr} is the #/ of electrons in the head of the avalanche.

$$E_{sc} \sim \frac{eN}{4\pi\epsilon_0 r^2} = 1.5 \times 10^6 \frac{N}{(1/\alpha)^2} \text{ V/cm}$$

For $N = 10^7, \alpha = 10^{-2} \text{ cm}$

$$E_{sc} \sim 15 \text{ kV/cm}$$

Streamers



- UV light emitted in recombination and de-excitation creates electrons by “photoionization” ahead and behind the avalanche so that a conducting bridge between anode and cathode is formed.
- Creating photoelectrons at larger distances from the main streamer can advance the growth of the breakdown channel rapidly.
 - $v = 100\text{-}1000 \text{ cm}/\mu\text{s}$ at atmospheric pressure was observed.

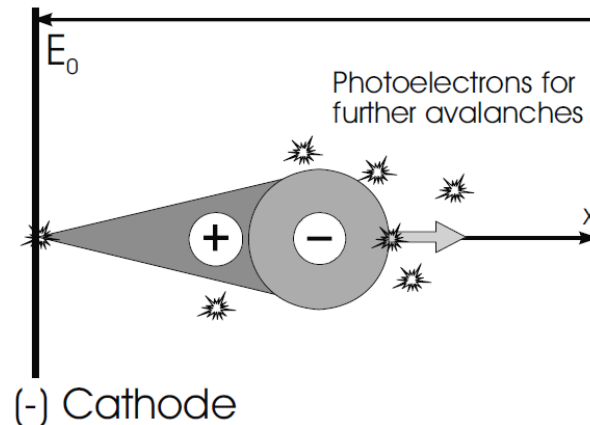

Streamers



- **Streamers - evocative of a thin band of bright light, attached at one end to an electrode and floating toward the other – “kanals”. (Channel in German)**
- **Cathode – directed (positive) streamers, from anode toward cathode.**
- **Anode – directed (negative) streamers, from cathode toward anode.**
- **Single-electron avalanche -> streamer – Streamers develop when the charge density at the head of the avalanche becomes so large that it distorts the applied electric field, i.e., space charge in the avalanche head generates a self-electric field that is on the order of the applied electric field.**

The cathode-directed (positive) streamer (A \rightarrow K)

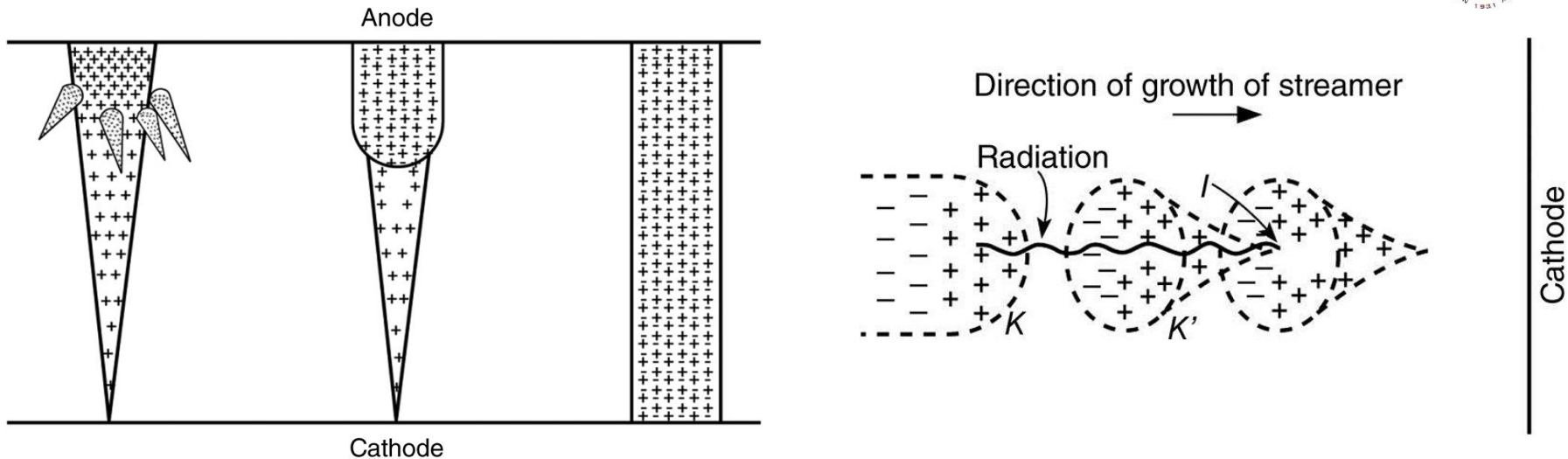

- When the avalanche has crossed the gap, electrons are swept into the anode, the positive ions remaining in a cone-shaped volume extending across the gap.
- The streamer grows with the help of photonization.

The anode-directed (negative) streamer (k → A)



- Negative streamer

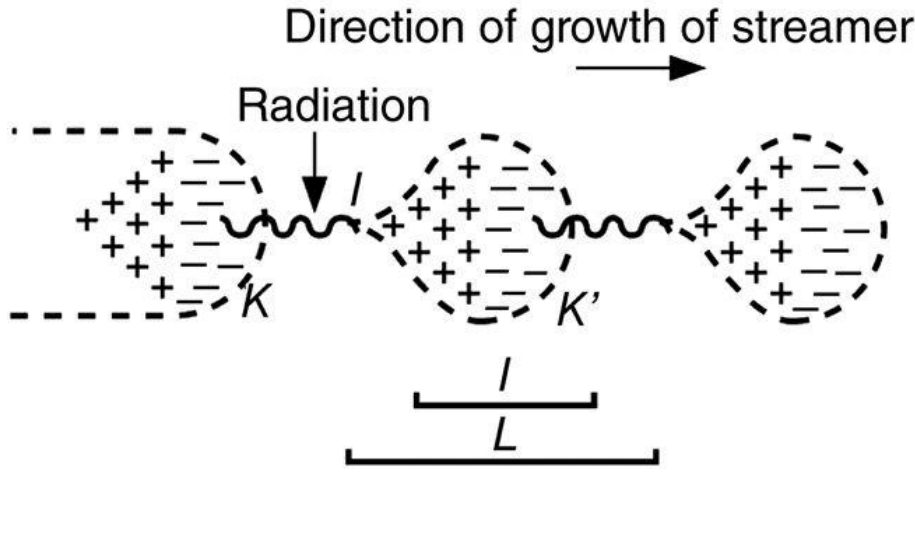

- Positive streamer

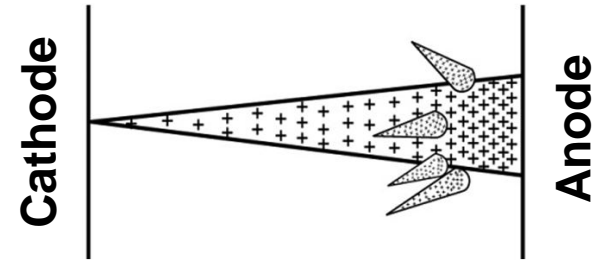

- The negative streamer happens when the primary avalanche becomes sufficiently strong before reaching the anode.
 - $N_{cr} \sim 10^8$ where N_{cr} is the #/ of electrons in the head of the avalanche.

The overvolted streamer

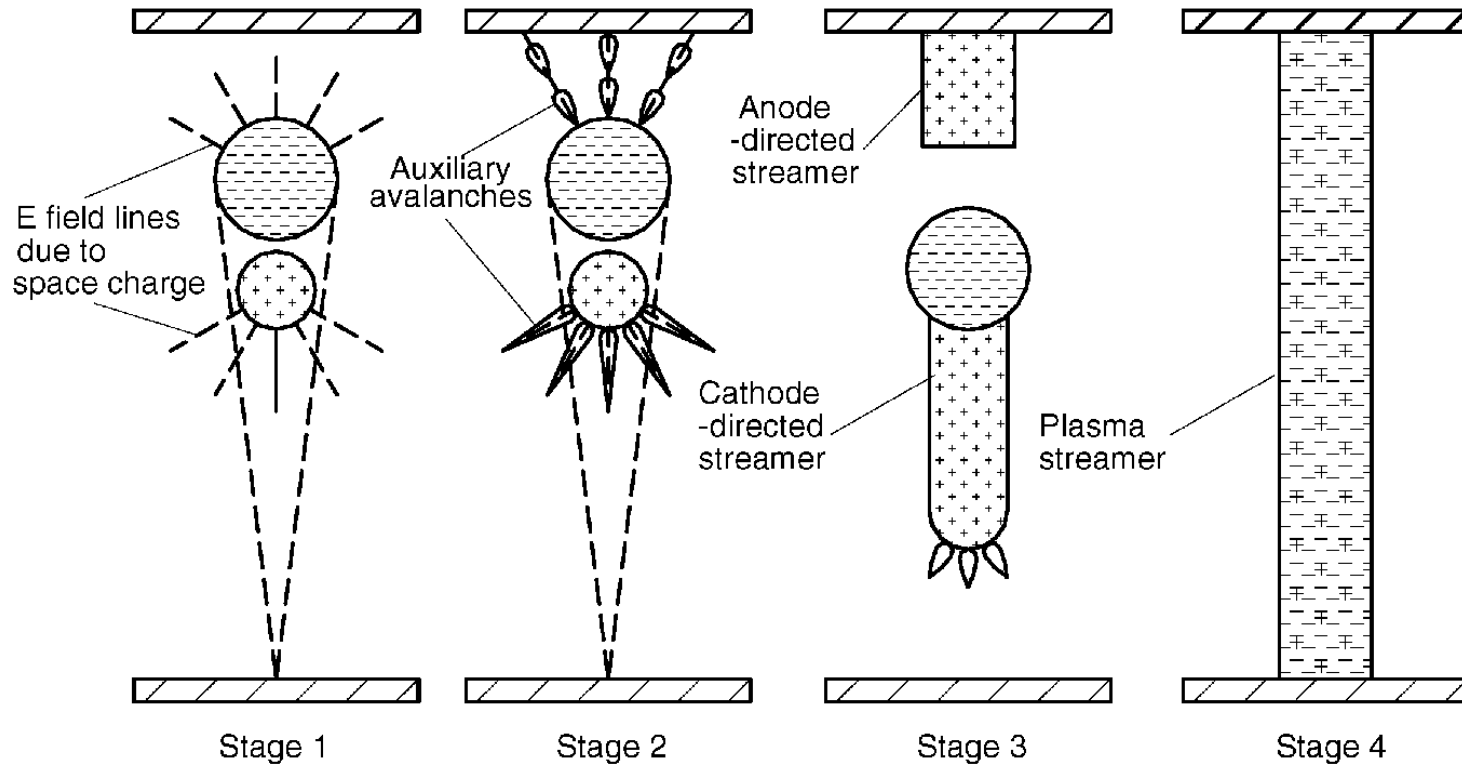

A voltage cross the gap higher than the static breakdown voltage occurs in a pulsed breakdown



- If a fast-rising pulse across the gap, we must take into account the fact that it takes a finite time before a breakdown can occur.
- Free electrons can be created by illuminating the gap volume or the cathode surface with electromagnetic radiation, in particular UV light, x rays and γ radiations.

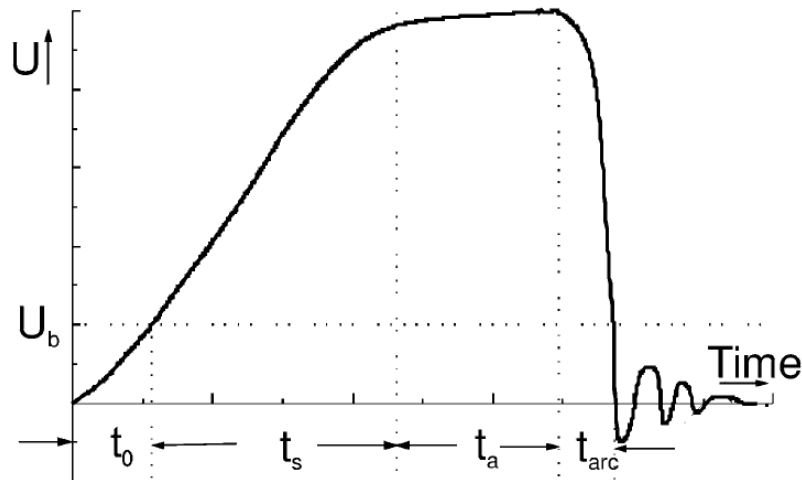

- U_b : The static breakdown voltage.
- t_0 : the time until the static breakdown U_b is exceeded.
- t_s : statistical delay time until an electron is able to create an avalanche resulting from the statistics of electron appearance.
- t_a : the avalanche build-up time until the critical charge density is reached.
- t_{arc} : the time required to establish a low-resistance arc across the gap.

The corona discharge – a small current leakage across a gap before a breakdown happens



- **Corona is a luminous, audible discharge that occurs when an excessive localized electric field gradient causes ionization in the surrounding gas.**
 - **Luminous discharge:** colored glow, frequently visible in darkened environment.
 - **Audible discharge:** a subtle hissing sound, louder with high voltage.
- **It manifests easily in highly nonuniform electric field geometries, such as point-to-plane electrodes or cylindrical geometries with inner conductors made of wire.**

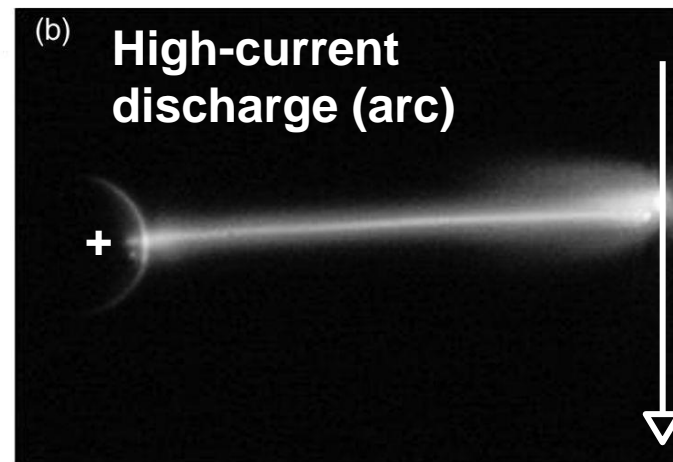
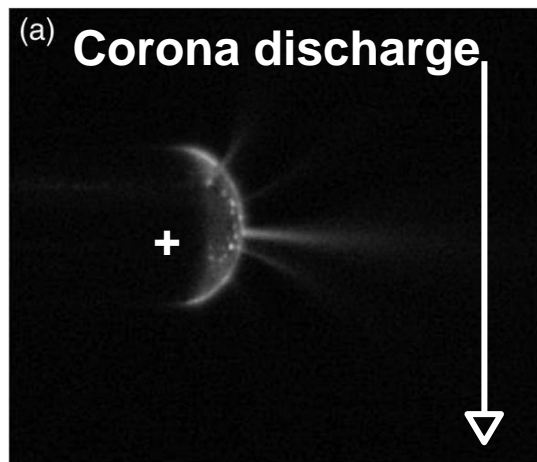

Don't bring a long stick to a train station

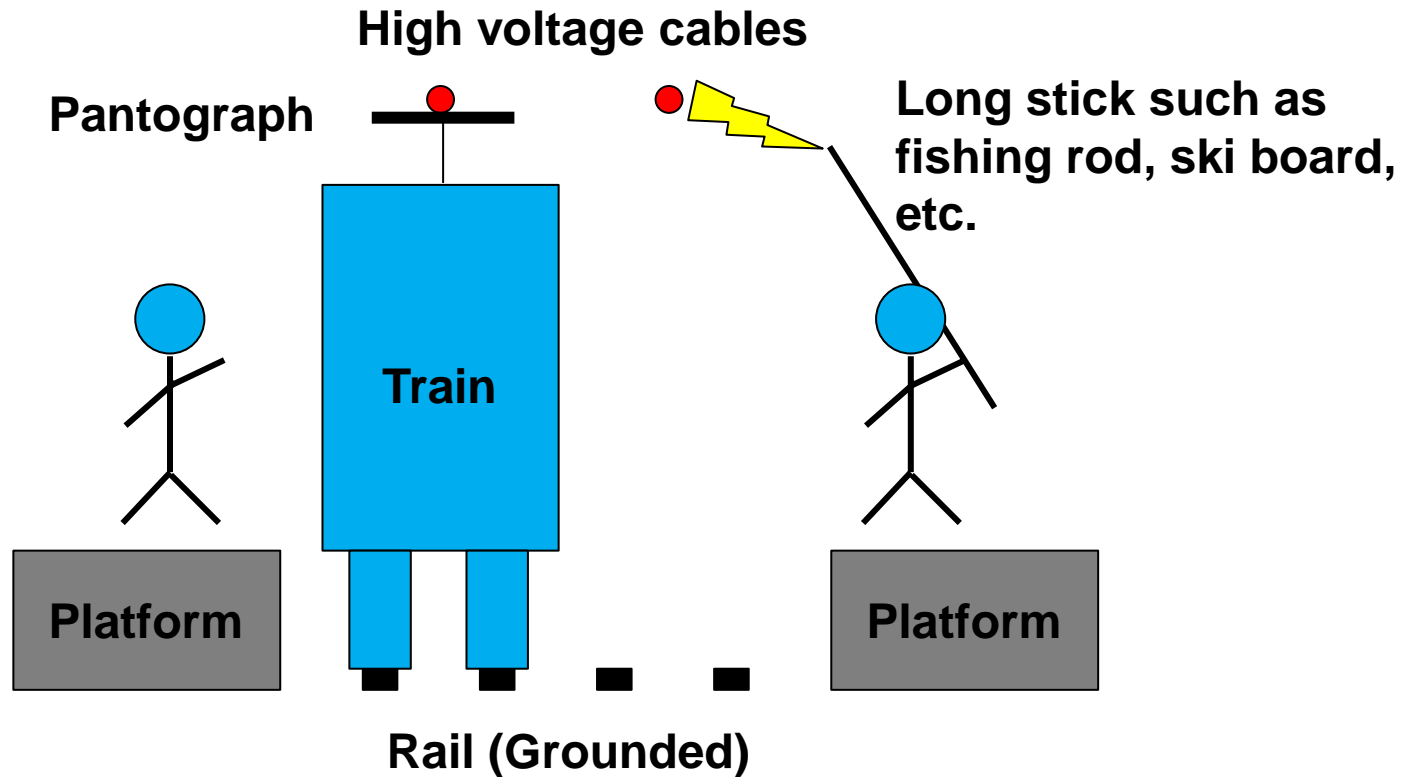

The corona discharge happens when the electric field is not uniform

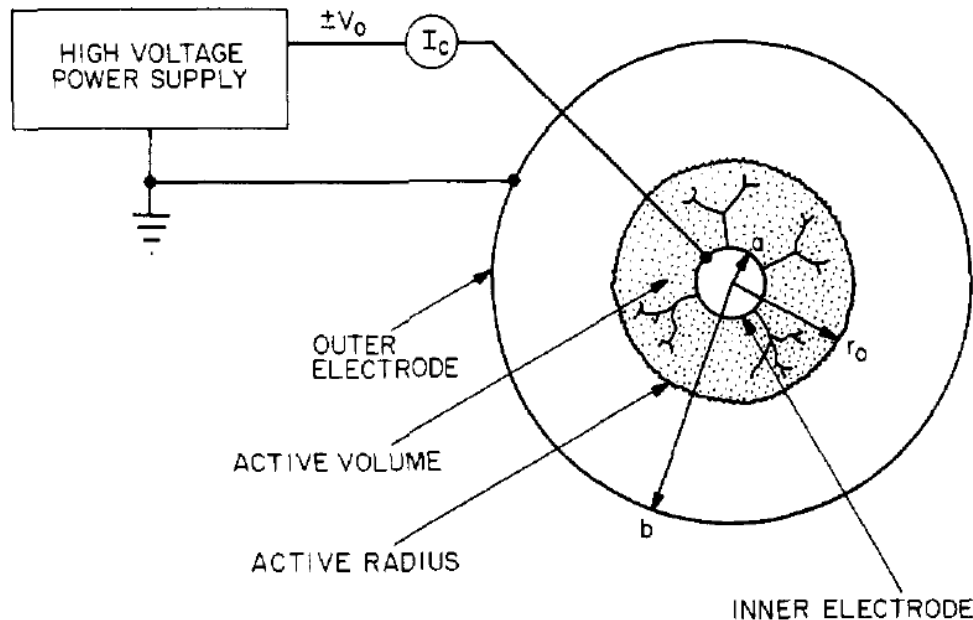

- The point of corona initiation is that point at which the voltage on the inner conductor of radius a is high enough that corona is just detectable.
- The electric field will drop off to the breakdown value at a radius r_0 called the active radius.
- Electrons are attached to molecular forming negatively charged ions to close the current loop. No additional avalanche can happen.

Corona can occur for both positive and negative polarity



- **Positive polarity**

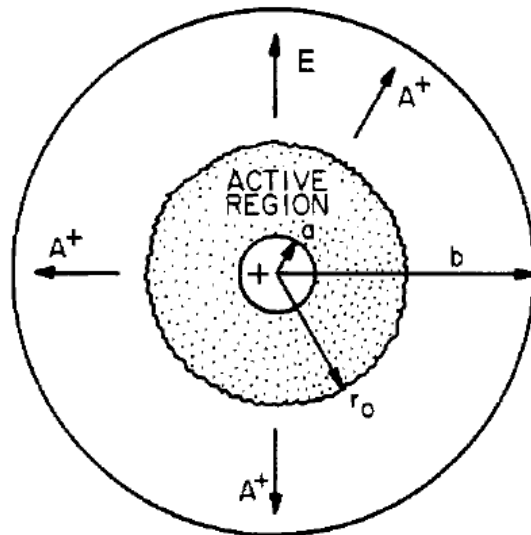

- **Negative polarity**

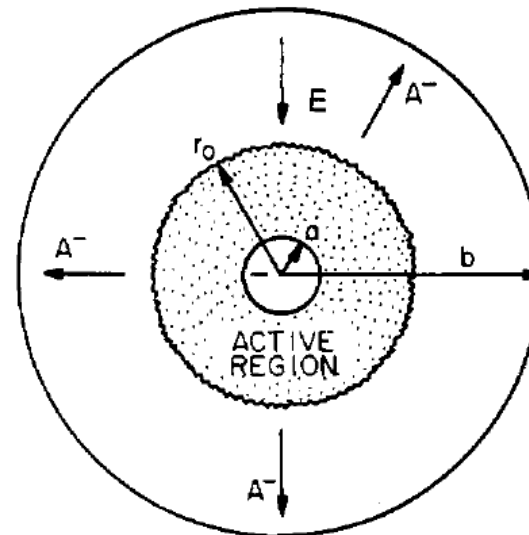

- The initiation voltages or coronal current are slightly different between positive and negative polarity.
- A continuous (positive polarity, DC) or intermittent (negative polarity, usually) current, usually in the order of $\mu\text{A} \sim \text{mA}$ per decimeter of length will flow to the power supply.

Negative point corona, also known as Trichel pulses

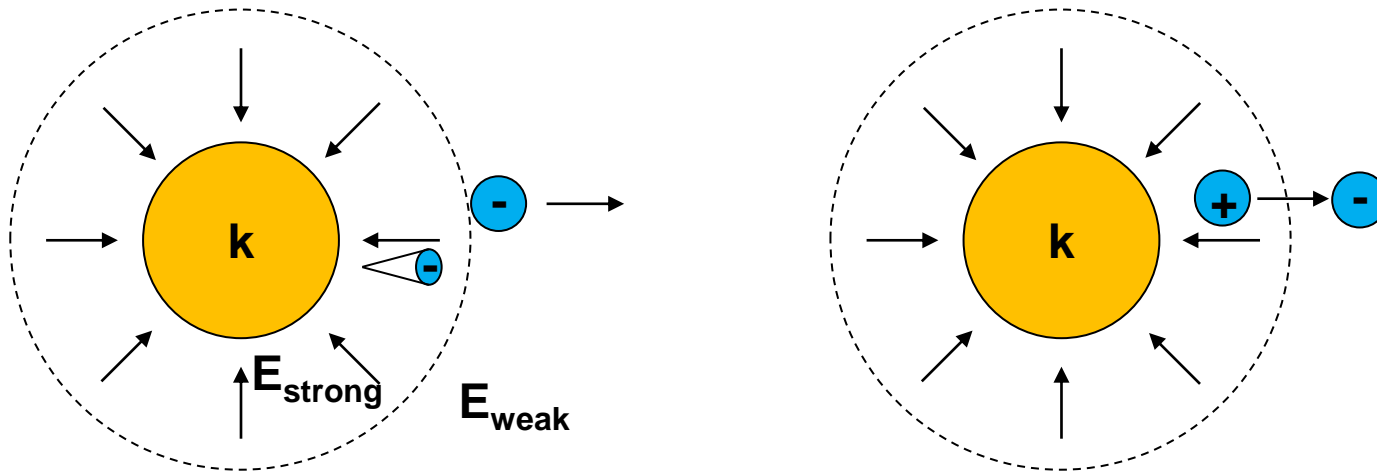

- **Avalanche toward anode occurs in the strong electric field region.**
- **No further ionization occurs in the weak field region.**
- **Electrons are slow down by positively charged ions (ion+) behind.**
- **Electrons attach to gas molecules forming negatively charged ions (ion-).**
- **The presence of the negative ions reduces the electric field at the point electrode and the discharge extinguishes.**
- **When positively/negatively charged ions drifted away, the original high-field conditions are re-established**

Positive point corona

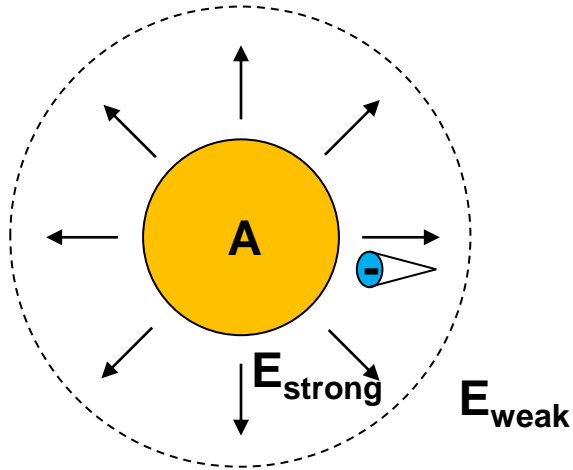

- **Electron avalanche initiated near the high-field region propagating toward anode.**
- **Streamer is developed.**
- **Lateral avalanches feed into the streamer core.**
- **Negative ion cloud is formed**

A corona discharge causes some problems even no breakdown occurs



- Ozone (O_3) is generated.
- Rubber is destroyed by O_3 .
- NO_3^+ is generated with moisture.
- Disadvantage:
 - Power losses.
 - Radio frequency (RF) interference.
 - Reduce the service life of solid and liquid insulation via initiating partial discharge.
 - Chemical decomposition.
- Advantage:
 - Pseudospark discharge – fast switch.
 - Electrostatic precipitator (dust remover) using corona discharge.

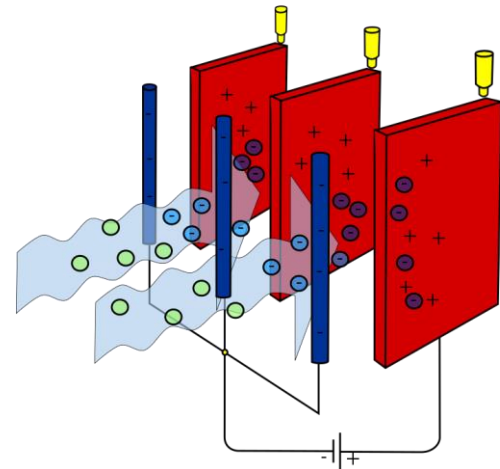

Tesla coil can generate high voltage

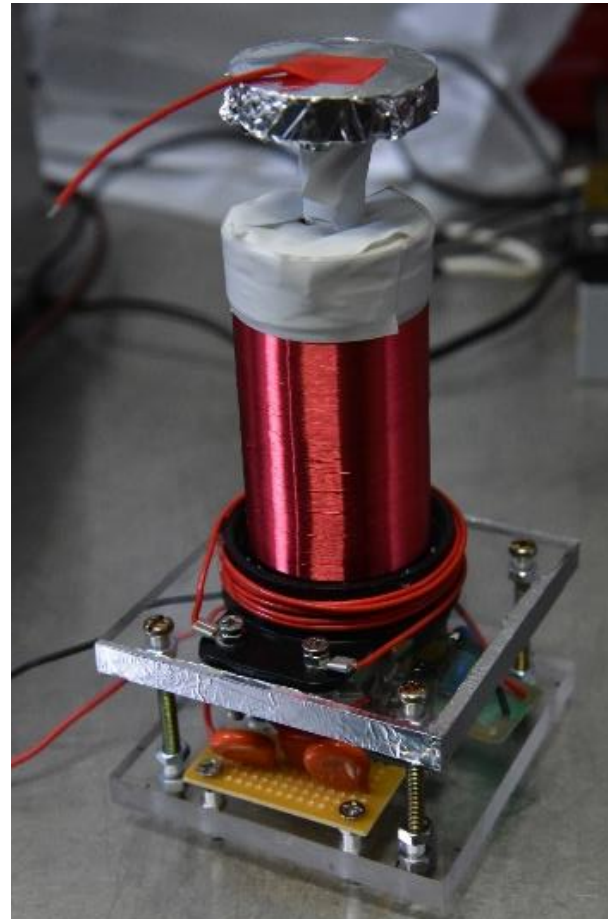

The high voltage is generated by two resonant LC circuits

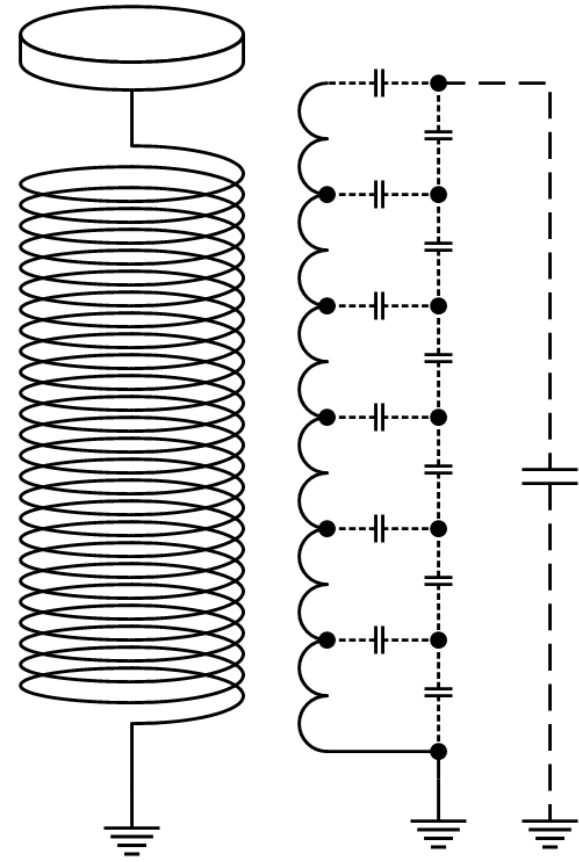
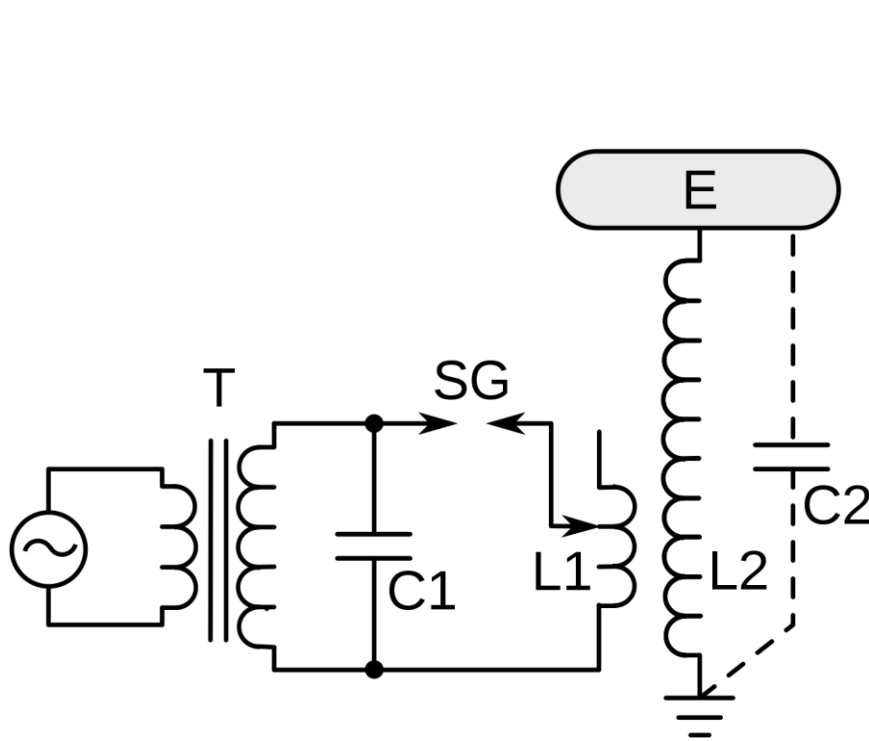

Energy is oscillating between the capacitor and the inductor

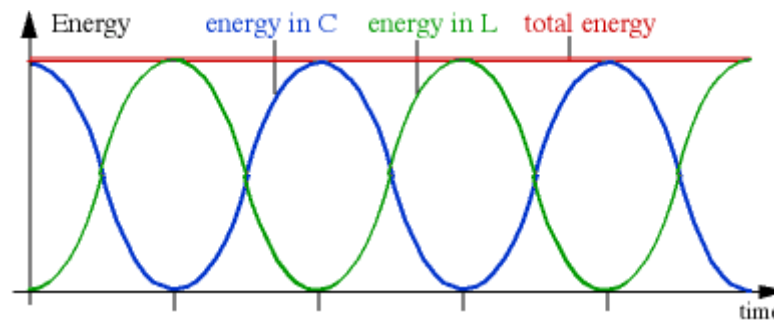
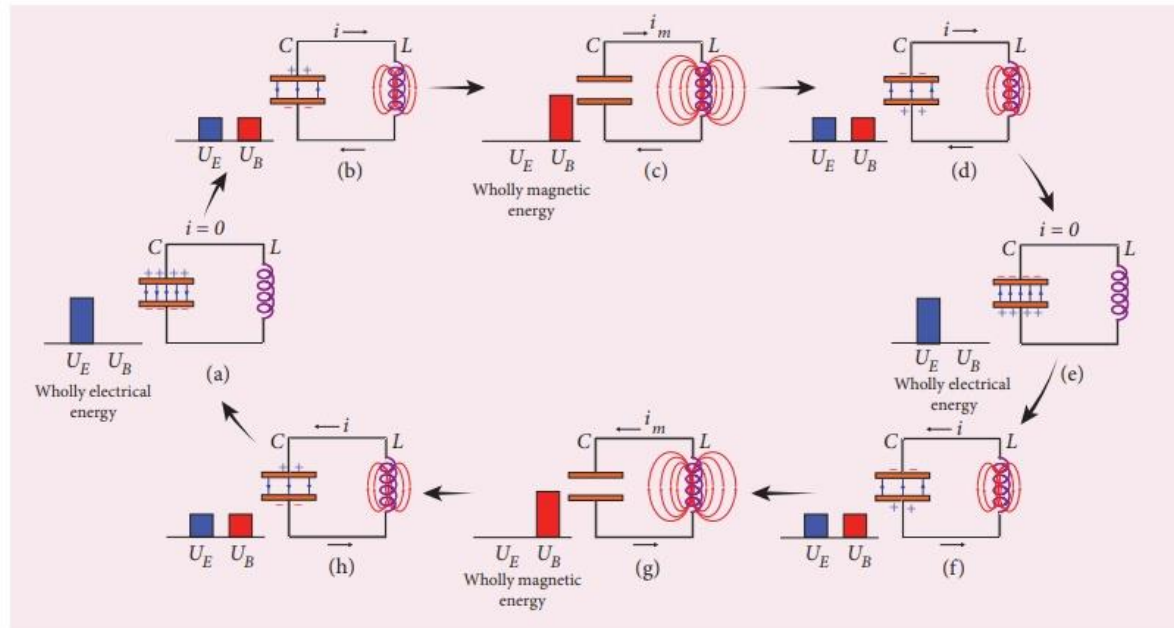

https://www.brainkart.com/article/Energy-conversion-during-LC-oscillations_38532/

http://ffden-2.phys.uaf.edu/webproj/211_fall_2016/Mark_Underwood/mark_underwood/Primary.html

Voltage of two separated coils can be transferred by mutual inductance between two coils

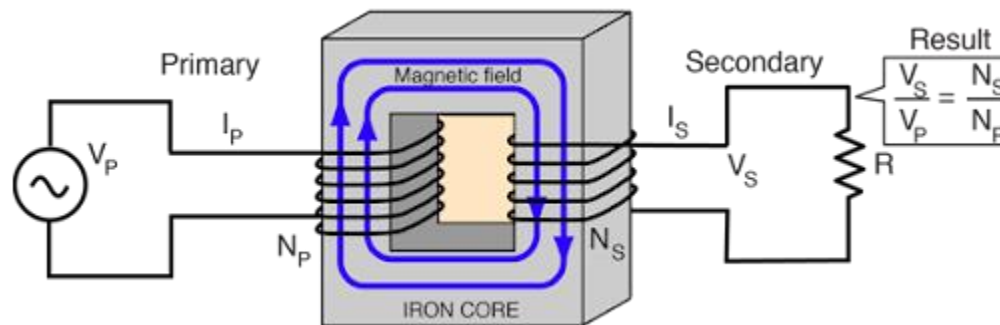
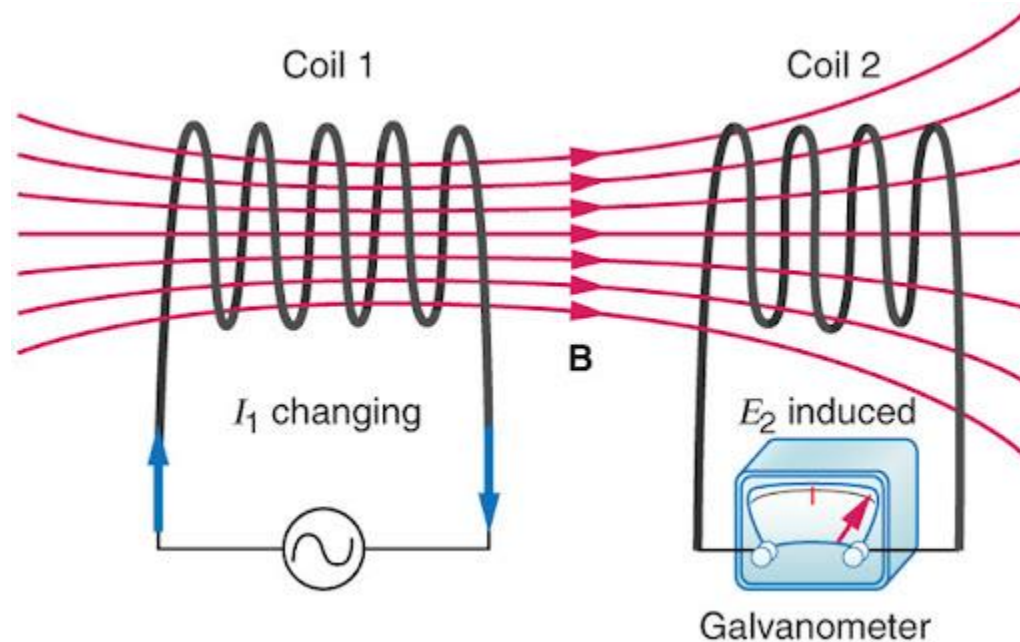

The high voltage is generated by two resonant LC circuits

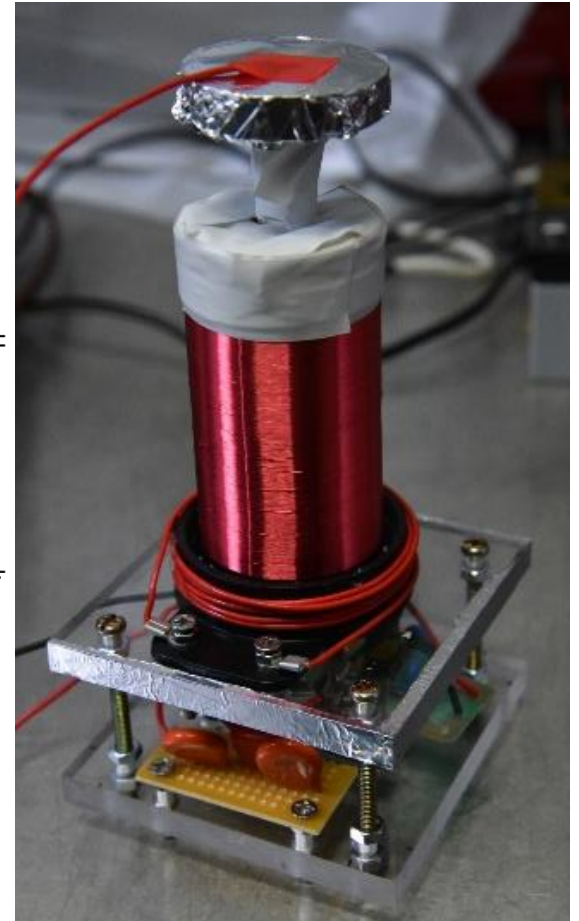
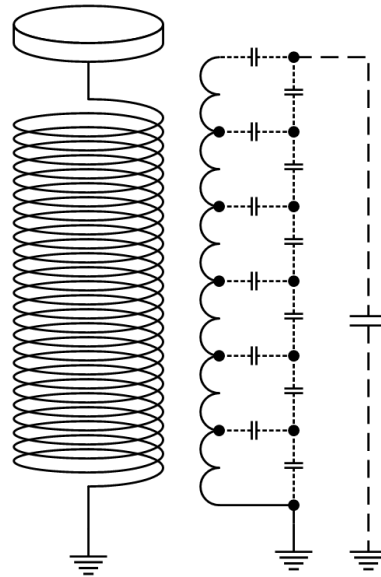
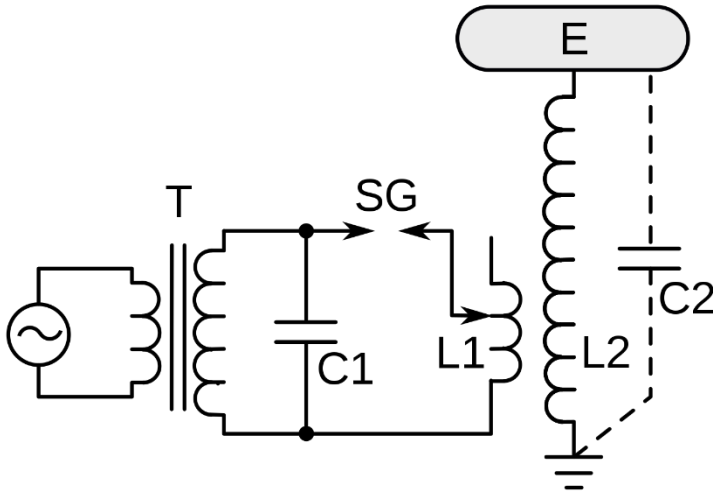

Components of the tesla coil

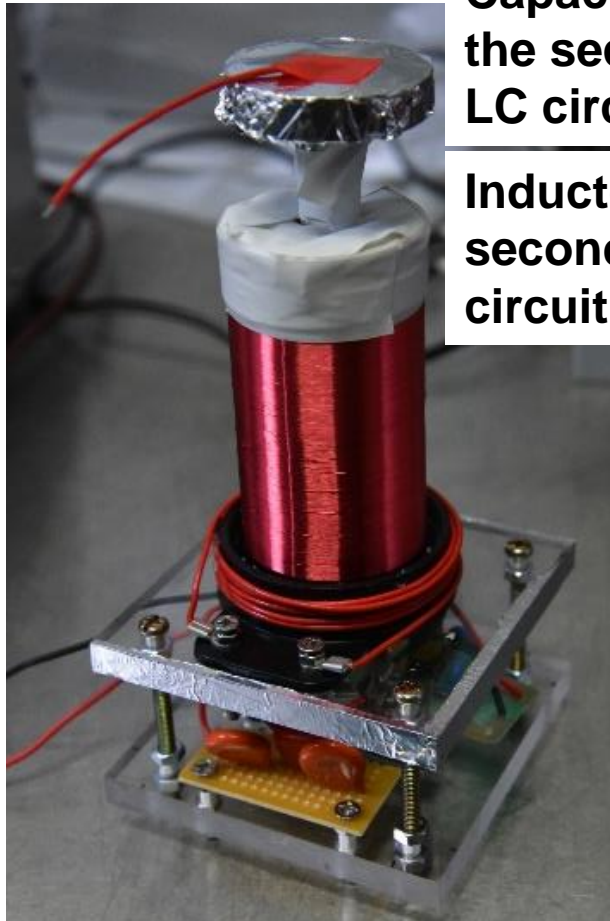

Capacitor of the secondary LC circuit

Inductor of the secondary LC circuit

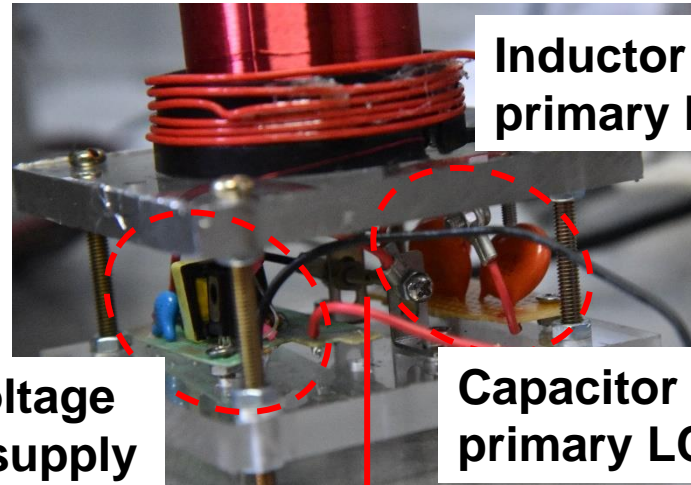

Inductor of the primary LC circuit

High voltage power supply

Capacitor of the primary LC circuit

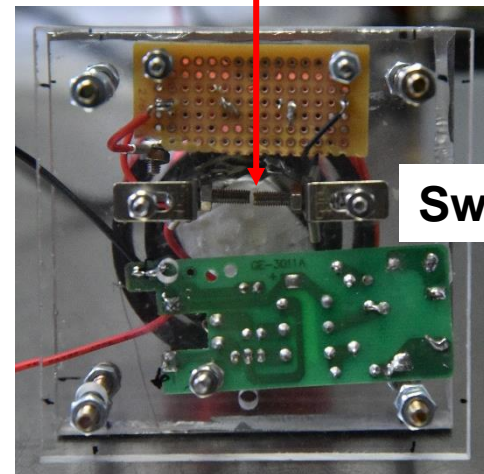

Switch

Show video.

Arc discharge occur between the high voltage and a grounded electrode

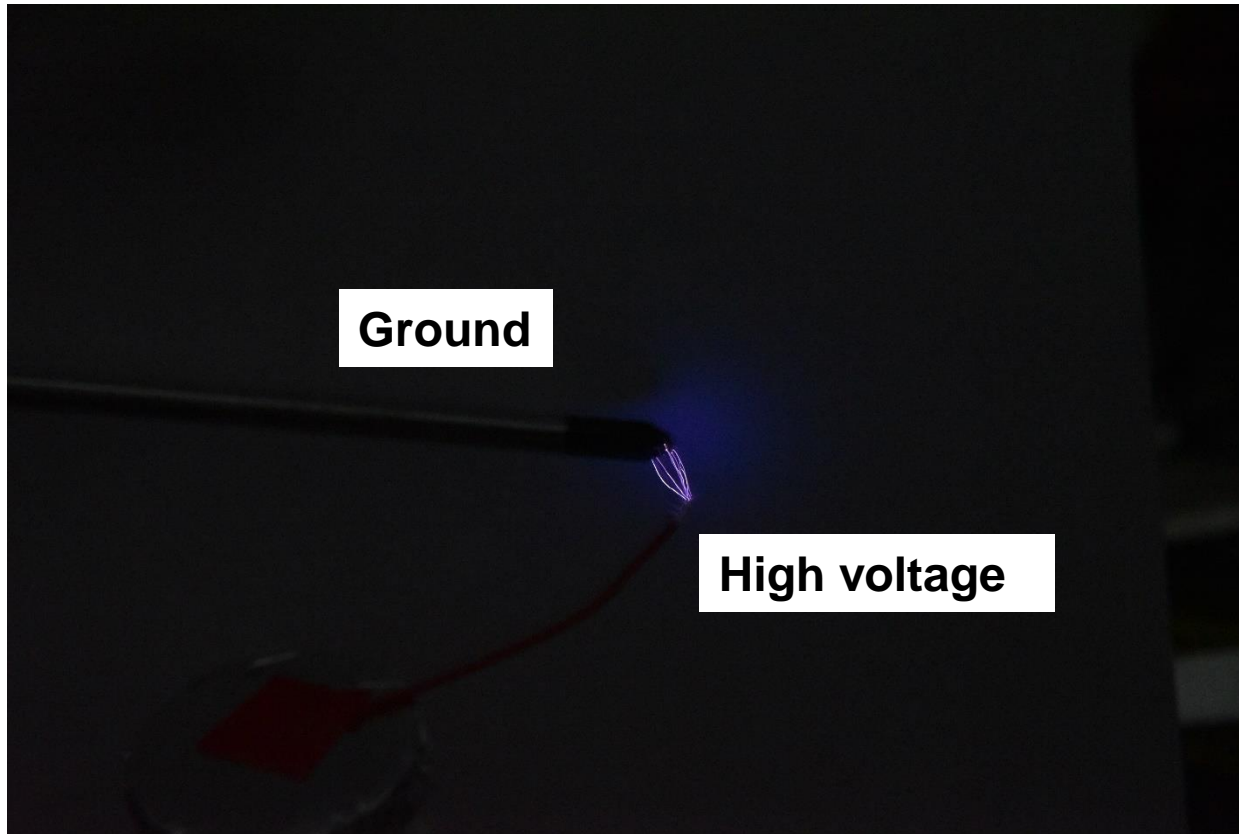

Corona discharge occurs when the electric field drops below a certain value

